



2024

PIER LUIGI



PAPIER Z KAMIENIA / STONE PAPER



PAPIER Z TRAWY / GRASS PAPER



PAPIER Z RECYKLINGU / RECYCLED PAPER

WZORY PAPIERÓW EKOLOGICZNYCH PREZENTUJEMY NA KOŃCU KATALOGU
MODELS OF ECOLOGICAL PAPERS ARE PRESENTED AT THE END OF THE CATALOGUE

SPIS TREŚCI / TABLE OF CONTENTS

DRZEWO ZA KALENDARZ / A TREE FOR A CALENDAR NEW	04
PAPIER Z NASIONAMI / PAPER WITH SEEDS	06
METODY ZNAKOWANIA / DEBOSSING METHODS	08
rPET	14
RE-COVER	16
QUERK	18
NATURA	20
SAVANA	22
GAMBO NEW	24
COLORADO NEW	26
CROSS	28
PIKO	30
METALLIC PRINT	32
GUMA	34
VIVELA	36
CANVAS	38
CANVAS LINE	40
CANVAS – SPINE / HORIZONT	42
KRAFT	44
DURO	45
IMAGE	46
FLESZ	47
IDEO	48
IDEO EXCLUSIVE	50
ZESTAWY PREMIUM / PREMIUM SETS	52
CARBON	54
ITALIANO – SKÓRA / LEATHER	56
PATKI / SYNTHETIC LEATHER TABS	58
KALENDARZ BIURKOWY STOJĄCY I LEŻĄCY / LYING AND STANDING DESK CALENDAR	60
OPAKOWANIA / PACKAGINGS	62
DODATKI / ADD-ONS	64
PROJEKT AUTORSKI / CUSTOMISED DESIGN	76
ZNAKOWANIE OPRAW / COVERS MARKING METHODS	77
ZESTAWIENIE ROKU / YEAR DESIGN	78
ŁĄCZENIE OPRAW / COVER COMBINATIONS	83
MATRYCE WIELKOFORMATOWE / LARGE FORMAT STAMPS	84
BLOKI KALENDARZY DZIENNYCH / DAILY CALENDARS LAYOUTS	86
BLOKI KALENDARZY TYGODNIOWYCH / WEEKLY CALENDARS LAYOUTS	90
BLOKI NOTESOWE / NOTEBOOKS LAYOUTS	102
GADŻETY ECO / ECO GADGETS	104
ROZGAŁĘŻNIKI USB / USB CHARGING CABLES	116
POWERBANKI / POWERBANKS	120
ENERGY SET	121
POWER SET	124
WHITE BOX & BLACK BOX	126
ZESTAWIENIE BLOKÓW / LIST OF BLOCKS	128



**POSADŹ
Z NAMI
DRZEWO!**

PLANT
A TREE
WITH US!

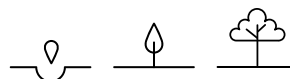

**PRZYCZYŃ SIĘ
DO OCHRONY
ŚRODOWISKA
NATURALNEGO
I ZRÓWNOWAŻONEGO
ROZWOJU**

CONTRIBUTE
TO PROTECTING
THE NATURAL
ENVIRONMENT
AND SUSTAINABLE
DEVELOPMENT

100 KALENDARZY /
CALENDARS



=

1 DRZEWO /
TREE



DZIĘKI PROGRAMOWI **POSADZIMY.PL** ZA KAŻDE ZAKUPIONE U NAS 100 KALENDARZY, ZASADZIMY 1 DRZEWO. / THANKS TO POSADZIMY.PL PROGRAMME, FOR EVERY 100 CALENDARS PURCHASED FROM US, WE WILL PLANT 1 TREE.

N1
NASIONA
SOSNY

PINE SEEDS

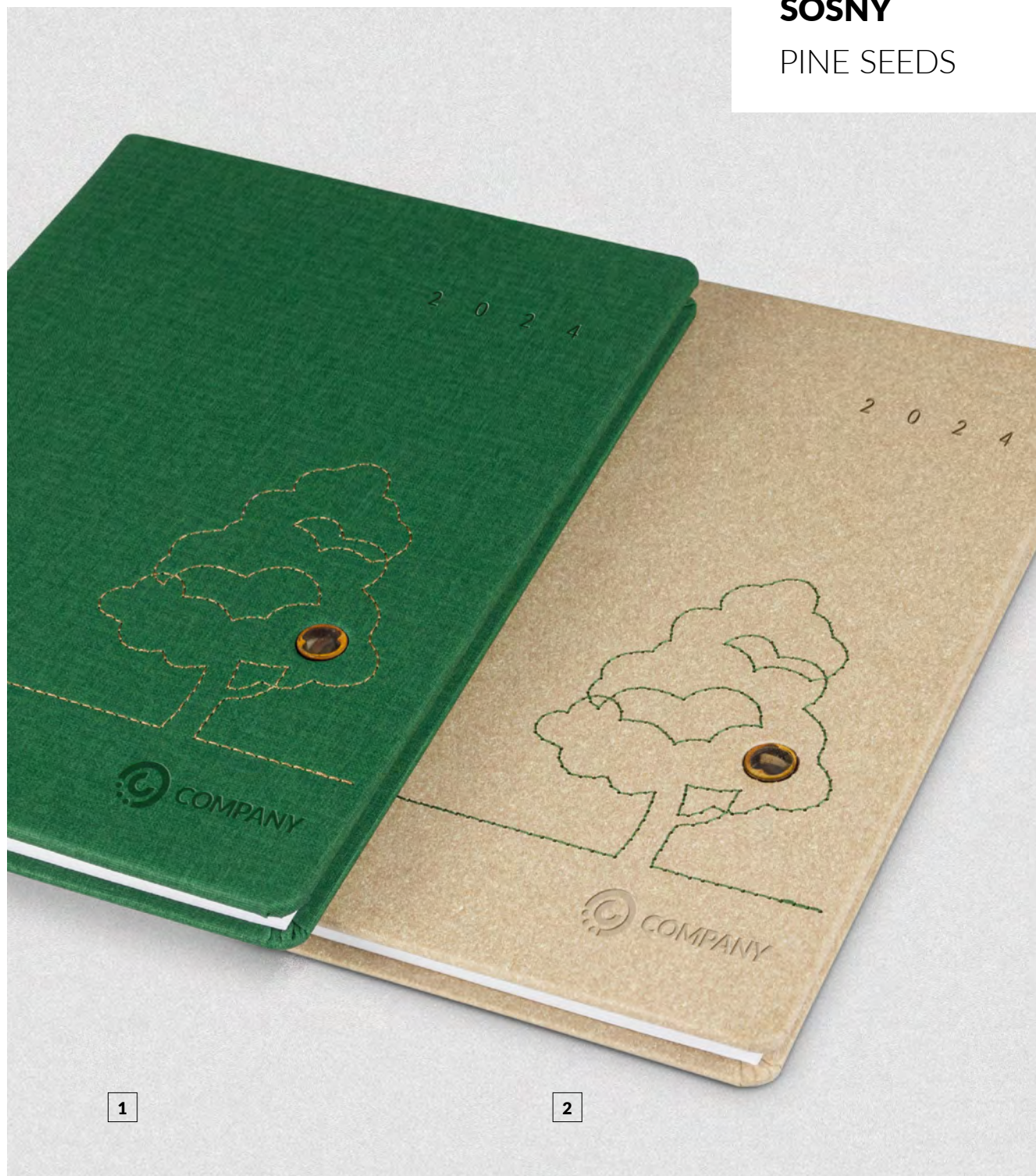

1

2

INSPIRACJA / INSPIRATION

rok / year design

12

oprawa / cover

1 - CANVAS, 2 - NATURA

znakowanie / marking method

łtłczenie, szycie kreatywne / debossing, creative stitching

dodatek / add-on

N1 **NEW**



**PAPIER
Z NASIONAMI
ZAWIERA
MIX
KWIATÓW POLNYCH**

PAPER
WITH SEEDS
CONTAINS
A MIX OF
FIELD FLOWERS

MAK POLNY / FIELD POPPY
STOKROTKA / DAISY
NIEZAPOMINAJKA / FORGET-ME-NOT
FIRLETKA / CATCHFLY



**POSADŹ,
PODLEJ,
PIELĘGNUJ!**

PLANT, WATER, CARE FOR!



wklejka / insert page

KSZTAŁTY / SHAPES

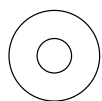

1 - Ø 90 mm



3 - 95 × 80 mm



5 - 68 × 90 mm



7 - 95 × 80 mm

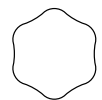

2 - 80 × 90 mm

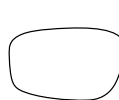

4 - 95 × 60 mm



6 - 90 × 90 mm

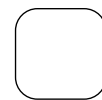

8 - 90 × 90 mm

A low-angle, upward-looking photograph of the stadium's steel and concrete structure against a bright sky. The image features a large, curved steel beam in the foreground, with several vertical support columns and cables extending upwards. The overall color palette is warm, with shades of brown, tan, and white.

STADION
ŚLĄSKI

CHORZÓW

PAPIER Z NASIONAMI
PAPER WITH SEEDS



INSPIRACJA / INSPIRATION

rok / year design

oprawa / cover

znakowanie / marking method

dodatek / add-on

drukowany / printed

RE-COVER

1 2 – druk / print

1 – M19

**STWÓRZ
WŁASNĄ
KREACJĘ**

CREATE YOUR
OWN DESIGN



3

4

INSPIRACJA / INSPIRATION

rok / year design

3 – 2B, 4 – drukowany / printed

oprawa / cover

3 – IDEO, 4 – GUMA

znakowanie / marking method

3 – druk, tłoczenie / print, debossing, 4 – druk / print

dodatek / add-on

4 – element autorski 3D / 3D customised element **NEW**



INSPIRACJA / INSPIRATION

rok / year design

1 - 20, 2 - B1 **NEW**

oprawa / cover

1 - IDEO, 2 - GAMBO

znakowanie / marking method

1 - **tłoczenie wielkoformatowe** / large format debossing*
2 - **tłoczenie wielkoformatowe, szycie kreatywne** /
large format debossing*, creative stitching

dodatek / add-on

1 - **finochrom autorski** / customised finochrome

*MATRYCE WIELKOFORMATOWE DO TŁOCZEŃ ZAMIESZCZONE SĄ NA STRONIE 84. / LARGE FORMAT STAMPS FOR THE DEBOSSING ARE AVAILABLE FROM PAGE 84.



INSPIRACJA / INSPIRATION

rok / year design

M4

oprawa / cover

IDEO

znakowanie / marking method

łtczenie wielkoformatowe autorskie, łtczenie foli, szycie kreatywne /
customised large format debossing, foil debossing, creative stitching

dodatek / add-on

M17B

METODY ZNAKOWANIA / DEBOSSING METHODS



INSPIRACJA / INSPIRATION

rok / year design

2 - 7

oprawa / cover

1 - IDEO, 2 - CROSS

znakowanie / marking method

1 - szycie kreatywne **LINE 2**, tłoczenie, grawer /
creative stitching **LINE 2**, debossing, engraving

2 - obszycie, tłoczenie, grawer / stitching, debossing, engraving

dodatek / add-on

1 - M21, 2 - M11

SUBTELNY PRZEKAZ

SUBTLE
MESSAGE



3

4

INSPIRACJA / INSPIRATION

rok / year design

3 - M3, 4 - 2B

oprawa / cover

GUMA

znakowanie / marking method

4 - tłoczenie, grawer / debossing, engraving

dodatek / add-on

3 - gumka pozioma płaska 10 mm / 10 mm horizontal elastic band

4 - gumka pionowa płaska 10 mm + M15, szlufka na długopis /
10 mm vertical elastic band + M15, elastic pen holder

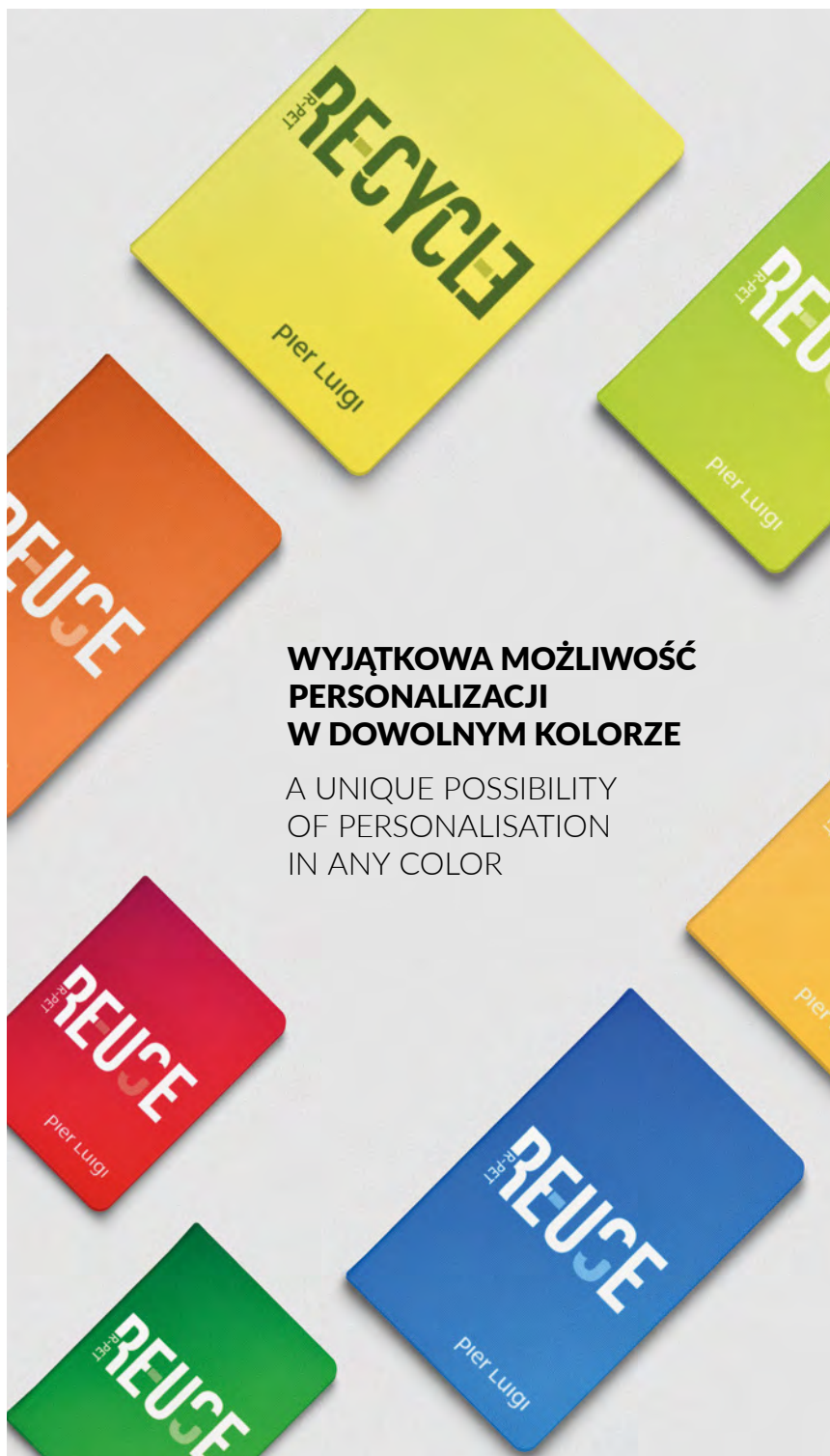

**WYJĄTKOWA MOŻLIWOŚĆ
PERSONALIZACJI
W DOWOLNYM KOLORZE**

A UNIQUE POSSIBILITY
OF PERSONALISATION
IN ANY COLOR

DRUK SUBLIMACYJNY / SUBLIMATION PRINTING



rPET

rok / year design

drukowany / printed

kolor / colour

biały / white

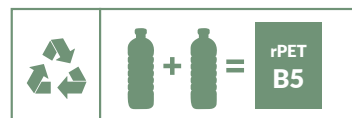

rPET jest materiałem **RECYKLINGOWYM** pozyskiwanym w 100% z odpadów pokonsumpcyjnych, najczęściej z butelek typu PET. Na 1 m² wykorzystuje się 12 butelek 1,5 litrowych. Materiał recyklingowy przeznaczony do druku sublimacyjnego – wg CMYK.

rPET is a **RECYCLING** material obtained in 100% from post-consumer waste, most often from PET bottles. 12 bottles of 1.5 liters are used per 1 m². Recycling material intended for sublimation printing – CMYK.

DEDYKOWANE ZNAKOWANIE OPRAW, UKŁADY KALENDARZY I NOTESÓW ZAMIESZCZONE SĄ OD STRONY 77. / DEDICATED MARKING METHODS OF COVERS, LAYOUTS OF CALENDARS AND NOTEBOOKS ARE AVAILABLE FROM PAGE 77.

rPET
DRUK
SUBLIMACYJNY
SUBLIMATION
PRINTING

rPET

WYBIERZ SWÓJ KALENDARZ LUB NOTES
Z BLOKIEM PAPIERU Z RECYKLINGU (~A5, ~B5),
ABY CIESZYĆ SIĘ 100% EKOLOGICZNYM
PRODUKTEM Z ODZYSKANYCH SUROWCÓW.

CHOOSE YOUR CALENDAR OR NOTEBOOK
WITH A BLOCK OF RECYCLED PAPER (~A5, ~B5),
TO ENJOY A 100% ECOLOGICAL PRODUCT
MADE OF RECYCLED RAW MATERIALS.



INSPIRACJA / INSPIRATION

rok / year design

drukowany / printed

oprawa / cover

rPET

znakowanie / marking method

druk sublimacyjny / sublimation printing

RE-COVER



INSPIRACJA / INSPIRATION

rok / year design

drukowany / printed

oprawa / cover

RE-COVER

znakowanie / marking method

druk / print

DEDYKOWANE ZNAKOWANIE OPRAW, UKŁADY KALENDARZY I NOTESÓW ZAMIESZCZONE SĄ OD STRONY 77. / DEDICATED MARKING METHODS OF COVERS, LAYOUTS OF CALENDARS AND NOTEBOOKS ARE AVAILABLE FROM PAGE 77.



RE-COVER

rok / year design

drukowany / printed

kolor / colour

beżowy / beige

grafitowy / graphite **NEW**

ceglany / brick **NEW**

Oprawa **RE-COVER** jest surowcem pozyskiwanym w procesie **recyklingu** ze skór naturalnych. Jest w pełni zgodna z rozporządzeniem REACH oraz konwencją waszyngtońską CITES. Parametry wytrzymałości są określone metodą EN ISO 3376:2011.

New cover called **RE-COVER** is a raw material obtained in the process of **recycling** natural leather. They are fully compliant with the REACH regulation and the Washington CITES Convention. The strength parameters are determined by the EN ISO 3376:2011 method.



INSPIRACJA / INSPIRATION

rok / year design

oprawa / cover

znakowanie / marking method

drukowany / printed

RE-COVER

druk / print

QUERK

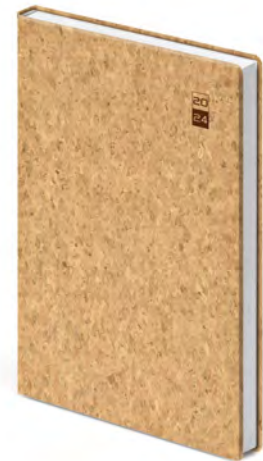
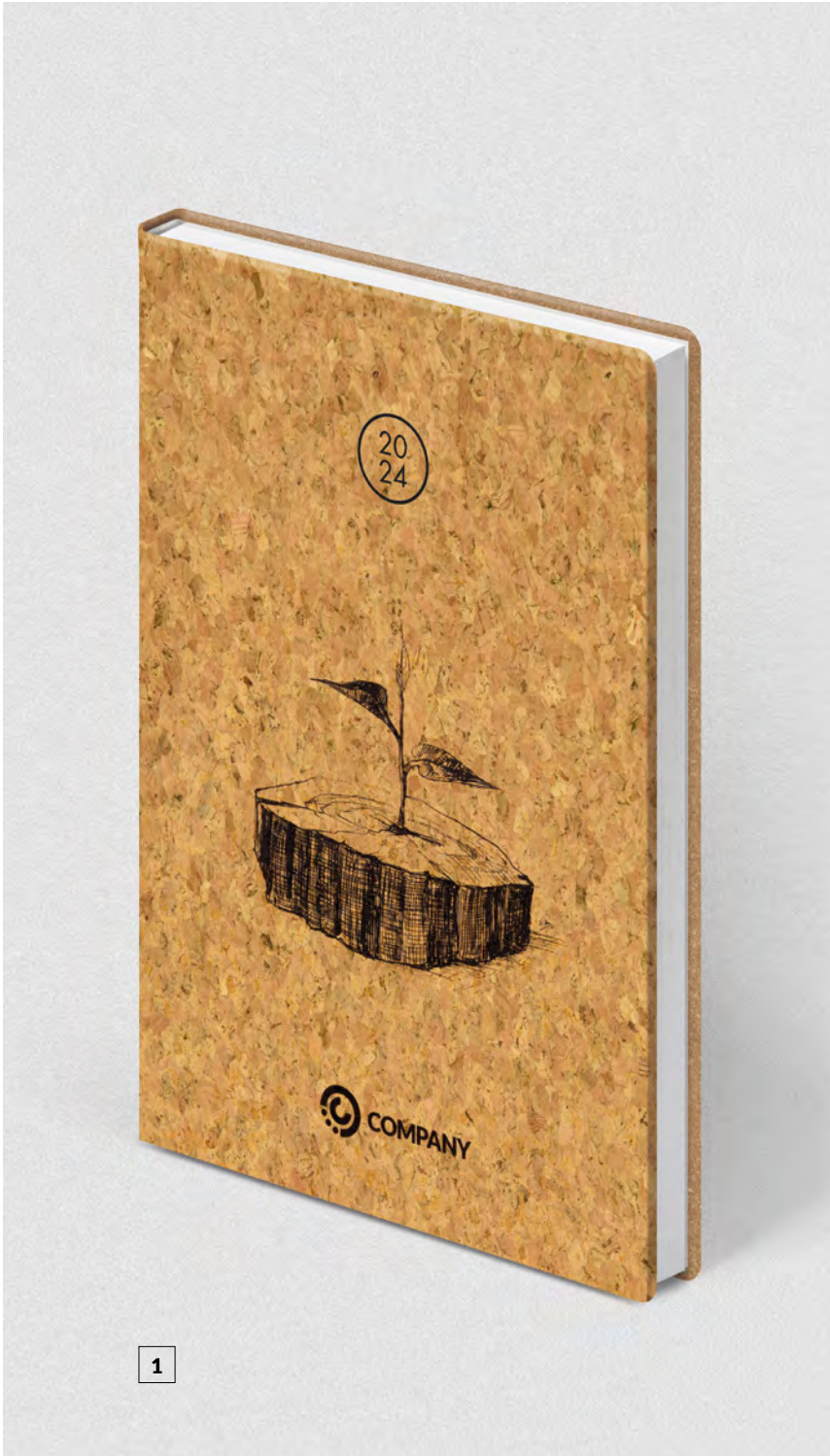

QUERK

rok / year design

drukowany / printed

kolor / colour

beżowy / beige

Korek to naturalny materiał pozyskiwany z kory dębu korkowego. Jest materiałem w pełni ekologicznym, a dodatkowo wegańskim. Nie ma dwóch takich samych fragmentów, co stanowi o wyjątkowości tego materiału.

Cork is a natural material obtained from the bark of the Quercus Suber. It is a fully ecological material and, additionally, vegan. There are no two identical pieces, which makes this material unique.

INSPIRACJA / INSPIRATION

rok / year design

drukowany / printed

oprawa / cover

QUERK

znakowanie / marking method

druk / print

DEDYKOWANE ZNAKOWANIE OPRAW, UKŁADY KALENDARZY I NOTESÓW ZAMIESZCZONE SĄ OD STRONY 77. / DEDICATED MARKING METHODS OF COVERS, LAYOUTS OF CALENDARS AND NOTEBOOKS ARE AVAILABLE FROM PAGE 77.

DBAJ O EKOLOGIĘ

TAKE CARE
OF THE
ENVIRONMENT



INSPIRACJA / INSPIRATION

rok / year design

oprawa / cover

znakowanie / marking method

dodatek / add-on

drukowany / printed

QUERK

druk / print

2 – gumka grzbietowa / spine elastic, G0072 **NEW** – długopis / pen, 3 – M16

NATURA

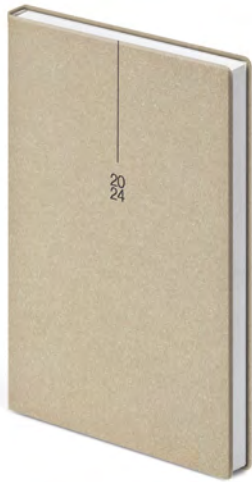

NATURA

rok / year design

18

kolor / colour

beżowy / beige

granatowy / dark blue

grafitowy / graphite

szary / grey **NEW**



OPRAWA **NATURA** Z CERTYFIKATEM FSC, KTÓRA DBA O LASY I PRZYSZŁOŚĆ NASZEJ PLANETY.

NATURA COVER WITH THE FSC CERTIFICATE, WHICH CARES FOR FORESTS AND THE FUTURE OF OUR PLANET.

DEDYKOWANE ZNAKOWANIE OPRAW, UKŁADY KALENDARZY I NOTESÓW ZAMIESZCZONE SĄ OD STRONY 77. / DEDICATED MARKING METHODS OF COVERS, LAYOUTS OF CALENDARS AND NOTEBOOKS ARE AVAILABLE FROM PAGE 77.

**DRUK
PATTERN
W JEDNYM
KOLORZE**

ONE COLOUR
PATTERN
PRINTING



1

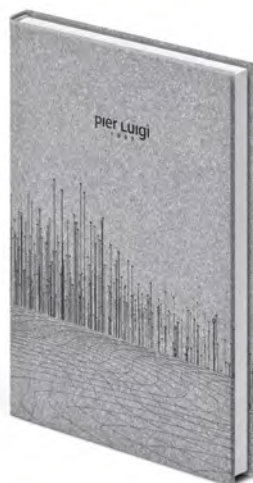

2

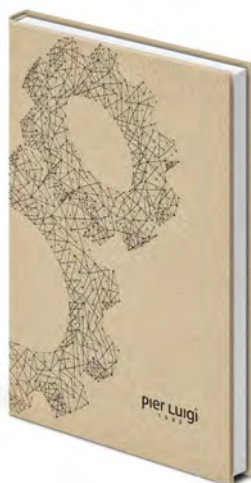

3

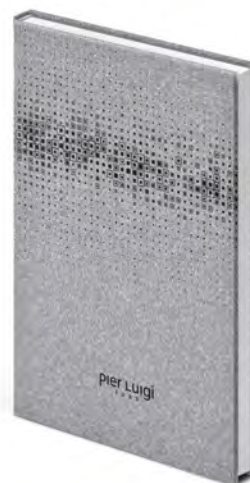

4

INSPIRACJA / INSPIRATION

rok / year design

oprawa / cover

znakowanie / marking method

drukowany na grzbiecie oprawy / printed on the spine of the cover

NATURA

druk / print

SAVANA

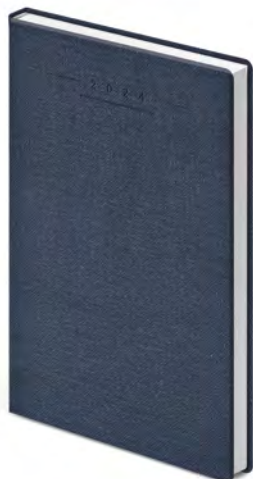
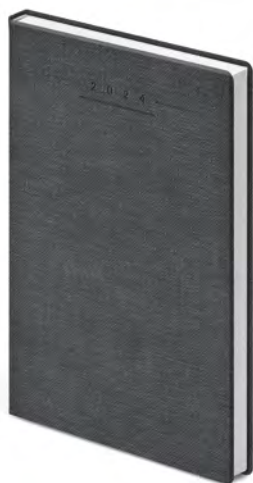

SAVANA

rok / year design

22

kolor / colour

beżowy / beige

grafitowy / graphite

szary / grey

granatowy / dark blue



100% EKOLOGICZNA OPRAWA **SAVANA** – POCHODZĄCA Z LASÓW ZARZĄDZANYCH ZGODNIE Z ZASADAMI ZRÓWNOWAŻONEGO ROZWOJU.

100% ECOLOGICAL **SAVANA** COVER – COMING FROM FORESTS MANAGED IN ACCORDANCE WITH THE PRINCIPLES OF SUSTAINABLE DEVELOPMENT.

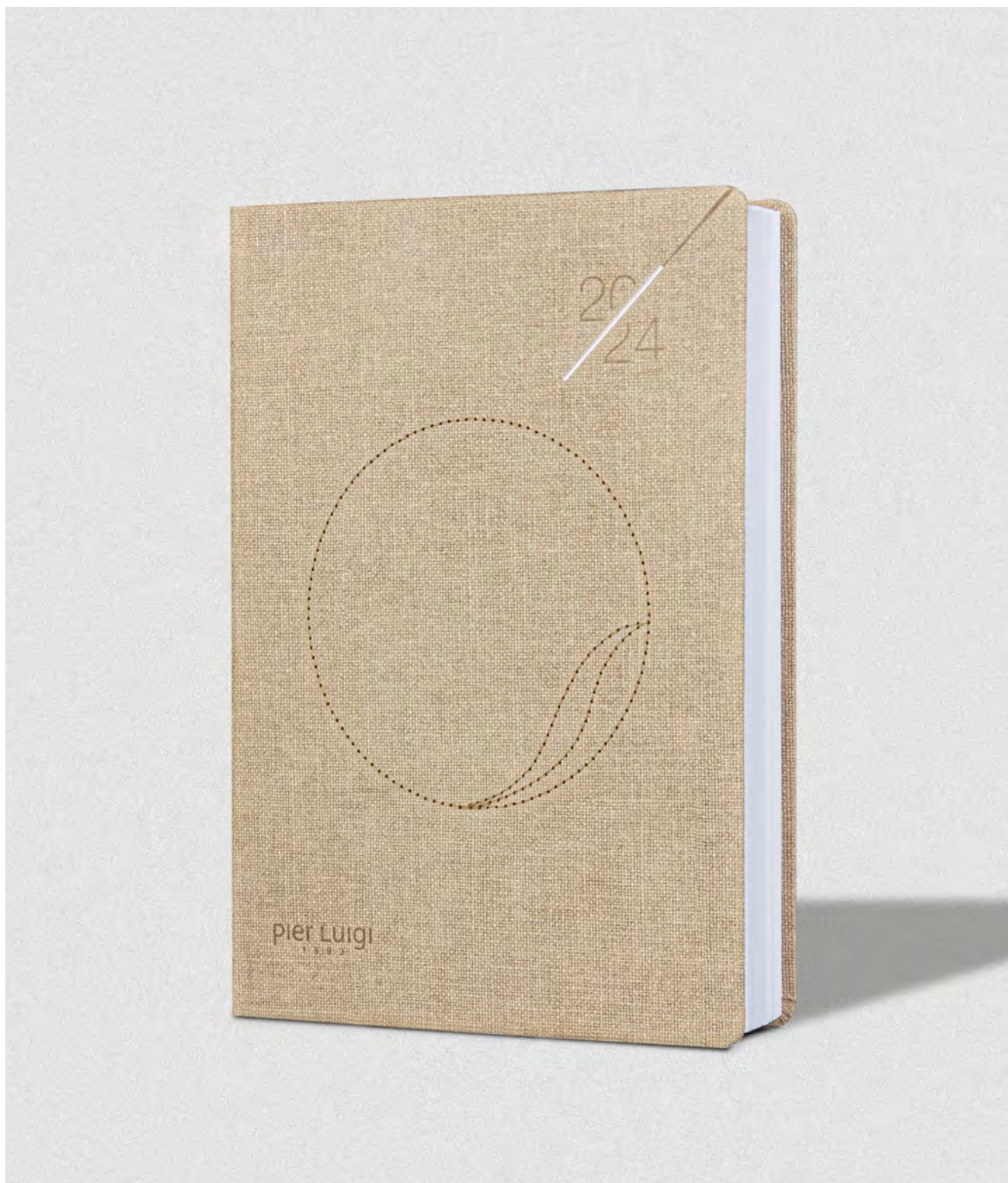

INSPIRACJA / INSPIRATION

rok / year design

16B

oprawa / cover

SAVANA

znakowanie / marking method

łóczenie, szycie kreatywne / debossing, creative stitching

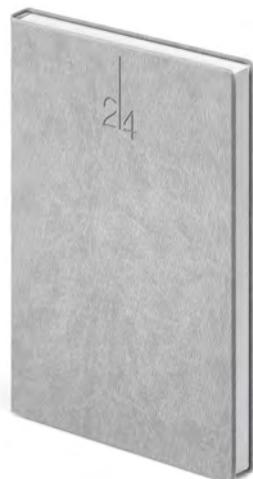
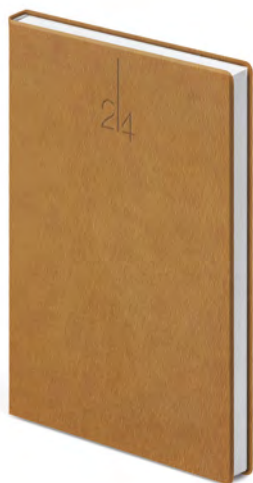

GAMBO

rok / year design

20

kolor / colour

zielony / green **NEW**
brązowy / brown **NEW**
szary / grey **NEW**
czarny / black **NEW**

B1 OKRĄG BAMBUSOWY / BAMBOO CIRCLE

MOŻLIWOŚĆ ZNAKOWANIA KALENDARZA ELEMENTEM Z BAMBUSA O STRUKTURZE **3D** NADAJE PRODUKTOWI NIEPOWTARZALNY CHARAKTER.

THE POSSIBILITY OF MARKING THE CALENDAR WITH A BAMBOO ELEMENT WITH A **3D** STRUCTURE GIVES THE PRODUCT A UNIQUE CHARACTER.

B1 NEW

**DODAJ
BAMBUSOWY
ELEMENT**

ADD A BAMBOO
ELEMENT



INSPIRACJA / INSPIRATION

rok / year design

oprawa / cover

znakowanie / marking method

dodatek / add-on

B1 NEW

GAMBO

1 – tłoczenie, przeszycie w pionie / debossing, vertical stitching

2 – tłoczenie wielkoformatowe / large format debossing

1 – szlufka na długopis / elastic pen holder, **G0073** NEW – długopis / pen

COLORADO **NEW**

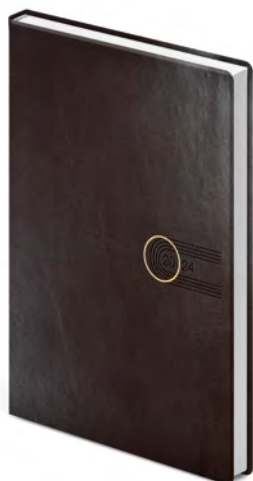
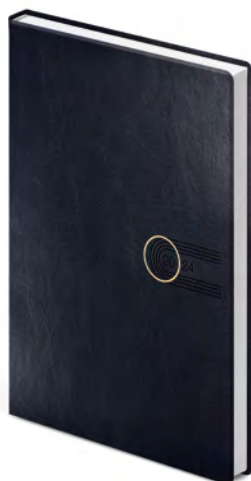
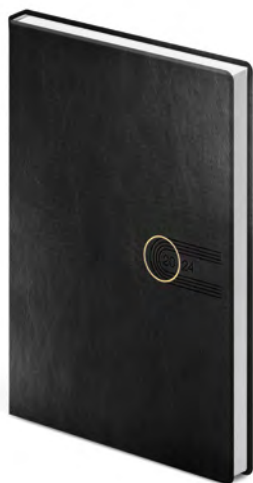

COLORADO

rok / year design

19A

kolor / colour

bordowy / maroon **NEW**

czarny / black **NEW**

granatowy / dark blue **NEW**

czekoladowy / chocolate **NEW**



DEDYKOWANE ZNAKOWANIE OPRAW, UKŁADY KALENDARZY I NOTESÓW ZAMIESZCZONE SĄ OD STRONY 77. / DEDICATED MARKING METHODS OF COVERS, LAYOUTS OF CALENDARS AND NOTEBOOKS ARE AVAILABLE FROM PAGE 77.



INSPIRACJA / INSPIRATION

rok / year design

4A

oprawa / cover

COLORADO

znakowanie / marking method

łtłczenie, szycie kreatywne / debossing, creative stitching

CROSS

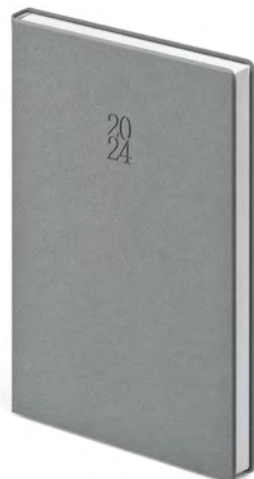
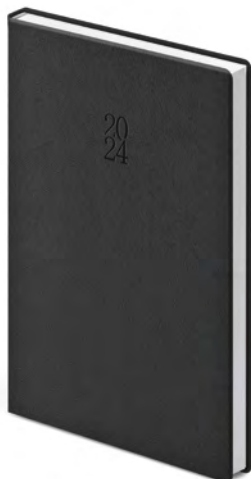

CROSS

rok / year design

6

kolor / colour

czerwony / red

granatowy / dark blue

czarny / black

szary / grey

zielony / green

pomarańczowy / orange **NEW**

DEDYKOWANE ZNAKOWANIE OPRAW, UKŁADY KALENDARZY I NOTESÓW ZAMIESZCZONE SĄ OD STRONY 77. / DEDICATED MARKING METHODS OF COVERS, LAYOUTS OF CALENDARS AND NOTEBOOKS ARE AVAILABLE FROM PAGE 77.

M16
ZASUWKA
METALOWA
METAL HASP



INSPIRACJA / INSPIRATION

rok / year design	7
oprawa / cover	CROSS
znakowanie / marking method	grawer, przeszycie w pionie / engraving, vertical stitching
dodatek / add-on	M16 + koperta / M16 + envelope*

*M16 NIEDOSTĘPNA DLA FORMATU 504T I BŁOKÓW Z PAPIERU Z TRAWY. / M16 NOT AVAILABLE FOR 504T OR GRASS PAPER BLOCKS.

PIKO



PIKO

rok / year design

2B

kolor / colour

szary / grey

czarny / black

granatowy mat / dark blue matte

granatowy błysk / dark blue shiny

brązowy / brown

DEDYKOWANE ZNAKOWANIE OPRAW, UKŁADY KALENDARZY I NOTESÓW ZAMIESZCZONE SĄ OD STRONY 77. / DEDICATED MARKING METHODS OF COVERS, LAYOUTS OF CALENDARS AND NOTEBOOKS ARE AVAILABLE FROM PAGE 77.



INSPIRACJA / INSPIRATION

rok / year design

1 - M4, **2** - 17A

oprawa / cover

PIKO

znakowanie / marking method

2 - **tłoczenie** / debossing

dodatek / add-on

1 - **gumka pionowa płaska 10 mm** / 10 mm flat elastic band

METALLIC PRINT



INSPIRACJA / INSPIRATION

wymiar / size

oprawa / cover*

uszlachetnienie oprawy / cover finishing

wykończenie / finishing

nakład / print run

pod każdy format / for any format

papier / paper

folia: soft touch / foil: soft touch

METALLIC PRINT – złoty, srebrny, hologramowy /
gold, silver, hologram

min. 200 szt. / MOQ 200 pcs.

*NAROŻNIKI OKŁADKI PAPIEROWEJ, TYLKO PROSTE ROGI NA TEKSTURZE TWARDEJ. / PAPER COVER CORNERS, ONLY STRAIGHT CORNERS.

**ZWYKŁA FOLIA
TO JUŻ ZA MAŁO**

STANDARD FOIL
IS NOT ENOUGH
ANYMORE



4



GUMA

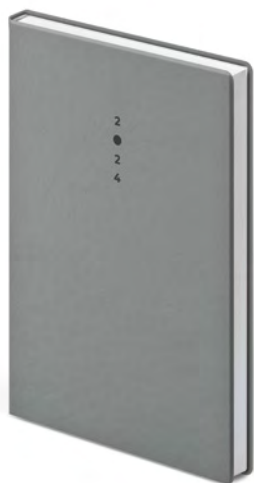

Druk UV / UV PRINT

GUMA

rok / year design

10

kolor / colour

czarny / black

szary / grey

granatowy / dark blue

czerwony / red

biały / white

DEDYKOWANE ZNAKOWANIE OPRAW, UKŁADY KALENDARZY I NOTESÓW ZAMIESZCZONE SĄ OD STRONY 77. / DEDICATED MARKING METHODS OF COVERS, LAYOUTS OF CALENDARS AND NOTEBOOKS ARE AVAILABLE FROM PAGE 77.

**NAJWYŻSZA
JAKOŚĆ DRUKU
W PEŁNYM
KOLORZE**

HIGHEST
QUALITY PRINTING
IN FULL COLOUR



INSPIRACJA / INSPIRATION

rok / year design

oprawa / cover

znakowanie / marking method

drukowany / printed

GUMA

druk UV / UV PRINT

VIVELA

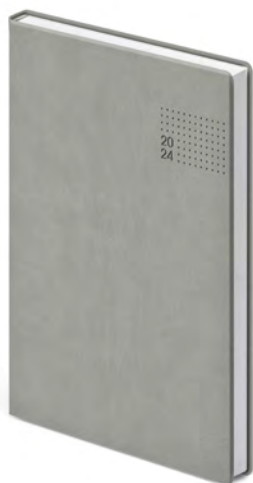

VIVELA

rok / year design

14

kolor / colour

czarny / black

szary / grey

niebieski / blue **NEW**

granatowy / dark blue

zielony / green

turkusowy / turquoise

czerwony / red

magenta / magenta

pomarańczowy / orange

żółty / yellow

beżowy / beige **NEW**

DEDYKOWANE ZNAKOWANIE OPRAW, UKŁADY KALENDARZY I NOTESÓW ZAMIESZCZONE SĄ OD STRONY 77. / DEDICATED MARKING METHODS OF COVERS, LAYOUTS OF CALENDARS AND NOTEBOOKS ARE AVAILABLE FROM PAGE 77.

M15
METAL
W TRENDACH

METAL
IN TRENDS



INSPIRACJA / INSPIRATION

rok / year design

12

oprawa / cover

VIVELA

znakowanie / marking method

grawer / engraving

dodatek / add-on

gumka pionowa płaska 10 mm + M15 / 10 mm vertical elastic band + M15



CANVAS

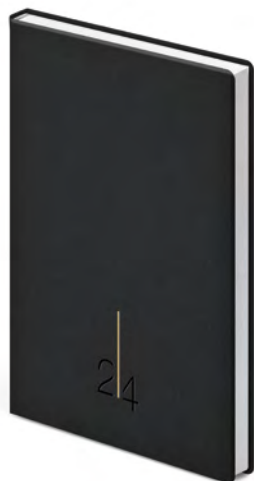
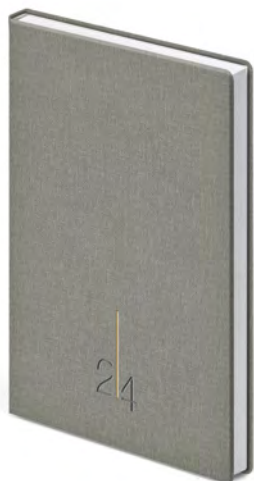
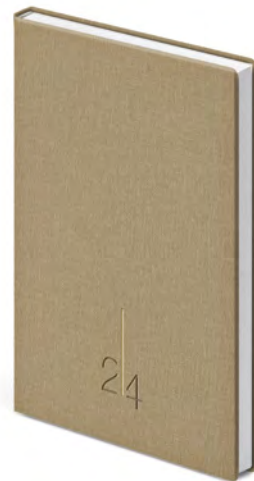
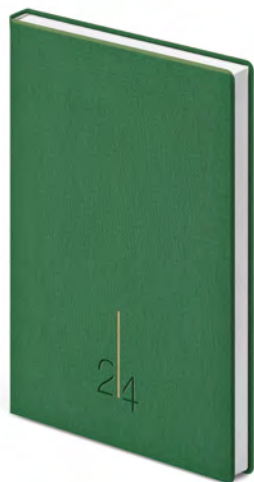
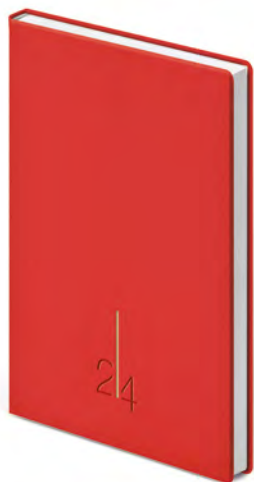

DRUK UV / UV PRINT



DEDYKOWANE ZNAKOWANIE OPRAW, UKŁADY KALENDARZY I NOTESÓW ZAMIESZCZONE SĄ OD STRONY 77. / DEDICATED MARKING METHODS OF COVERS, LAYOUTS OF CALENDARS AND NOTEBOOKS ARE AVAILABLE FROM PAGE 77.

SZYCIE KREATYWNE

CREATIVE
STITCHING

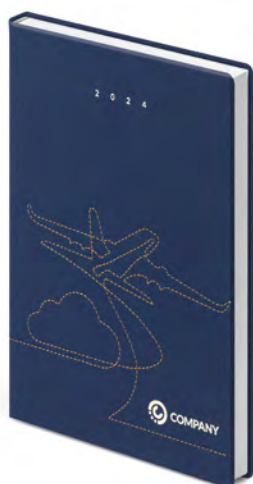

1

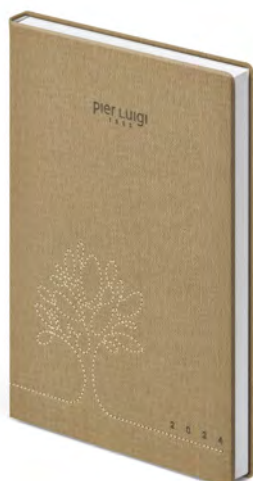

2

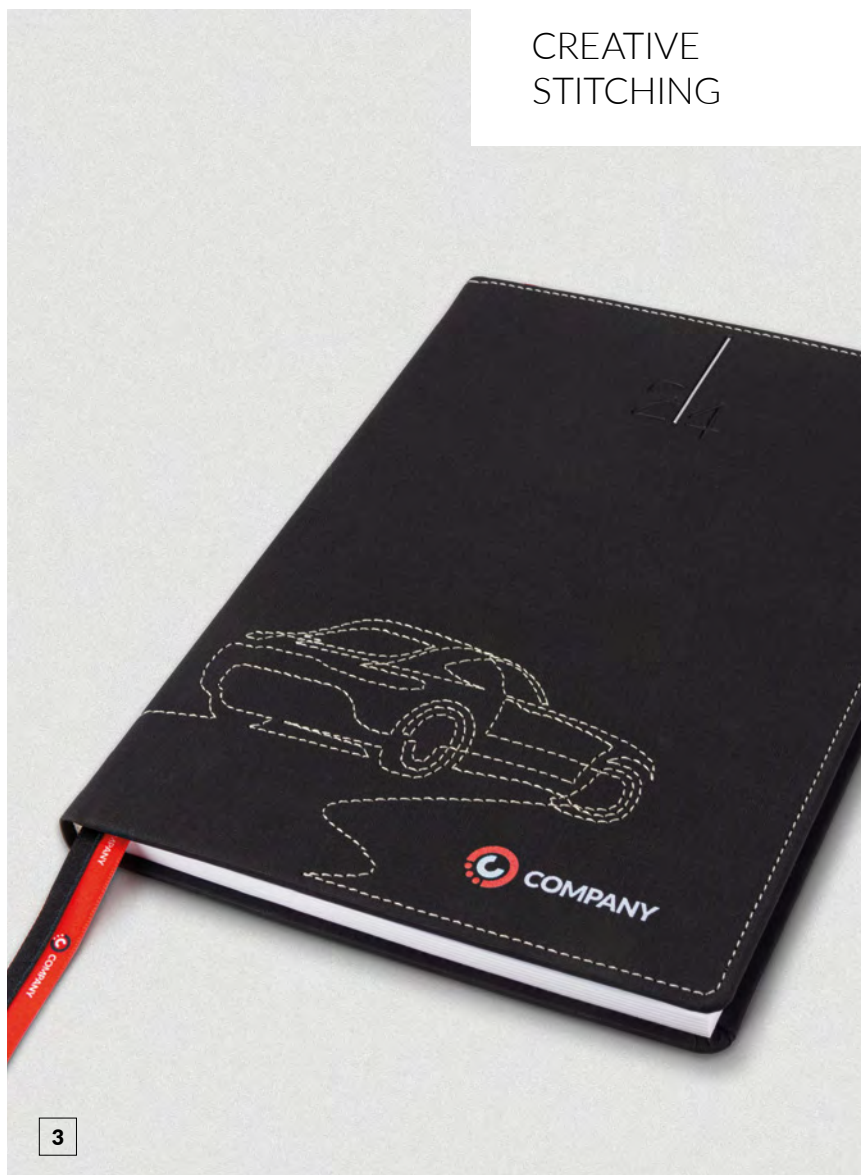

3

MOŻLIWOŚĆ WYKORZYSTANIA PREZENTOWANYCH WZORÓW LUB WYSZYCIA OPRAWY WG AUTORSKIEGO PROJEKTU. / POSSIBILITY TO USE THE PRESENTED PATTERNS OR EMBROIDER THE FRAME ACCORDING TO A CUSTOMISED DESIGN.

◀ CANVAS

rok / year design

20A

kolor / colour

czerwony / red
zielony / green
niebieski / blue
granatowy / dark blue
beżowy / beige
brązowy / brown
szary / grey
czarny / black
biały / white

INSPIRACJA / INSPIRATION

rok / year design

1 2 – drukowany / printed, 3 – 20B

oprawa / cover

CANVAS

1 – druk, szycie kreatywne / print, creative stitching
2 – tłoczenie, szycie kreatywne / debossing, creative stitching
3 – druk, tłoczenie, szycie kreatywne / print, debossing, creative stitching

znakowanie / marking method

projekt / design

kolor oprawy i nici do wyboru / cover colours and sewing threads to choose

dodatek / add-on

3 – tasiemka sublimacyjna / sublimation ribbon

CANVAS LINE



LINE 1



LINE 2

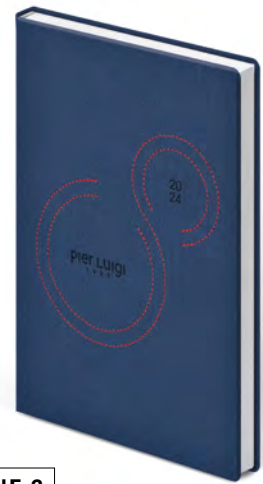

LINE 3



INSPIRACJA / INSPIRATION

rok / year design

LINE 1 LINE 2 – 12, LINE 3 – 7, LINE 4 – 9, LINE 5 – 16A, LINE 6 – 21A

oprawa / cover

CANVAS

znakowanie / marking method

łóczenie, szycie kreatywne / debossing, creative stitching

projekt / design

kolor oprawy i nici do wyboru / cover colours and sewing threads to choose

DEDYKOWANE ZNAKOWANIE OPRAW, UKŁADY KALENDARZY I NOTESÓW ZAMIESZCZONE SĄ OD STRONY 77. / DEDICATED MARKING METHODS OF COVERS, LAYOUTS OF CALENDARS AND NOTEBOOKS ARE AVAILABLE FROM PAGE 77.

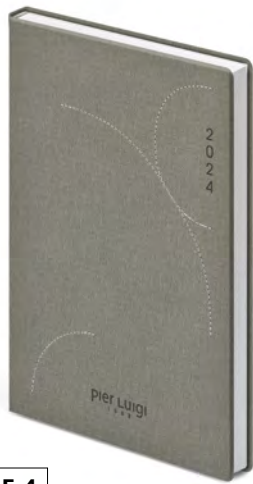

LINE 4

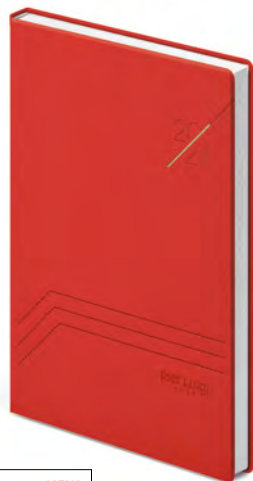

LINE 5 NEW



LINE 6 NEW



CANVAS - SPINE / HORIZONT

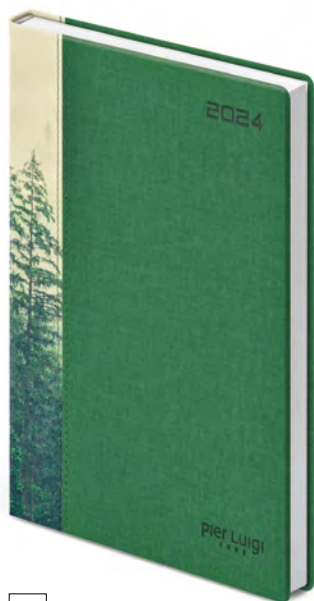

1



2

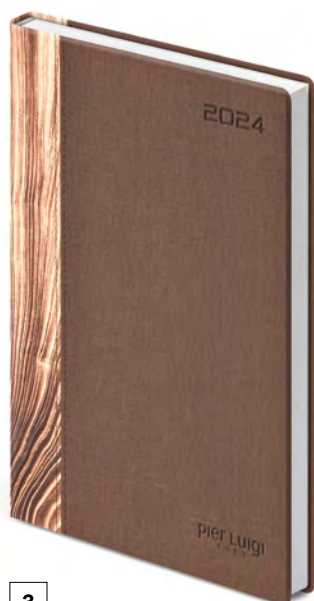

3



4

CANVAS - SPINE / HORIZONT

rok / year design

2B

oprawa / cover

CANVAS + CANVAS

łączenie opraw / cover combinations*

1 3 5 - 10 SPINE, 2 4 - 28 HORIZONT

znakowanie / marking method

druk UV, tłoczenie / UV print, debossing

projekt / design

kolor oprawy i nici do wyboru / cover colours and sewing threads to choose

*ŁĄCZENIE OPRAW CANVAS - SPINE / HORIZONT TYLKO NA TEKSTURZE TWARDEJ. / CONNECTING THE CANVAS COVER MATERIAL - SPINE / HORIZONT ONLY ON HARD CARDBOARD.

**TWOJA MARKA
W KOLORZE**

YOUR BRAND
IN COLOUR



2



5

KRAFT



KRAFT

rok / year design

M4

kolor / colour

granatowy / dark blue

grafitowy / graphite



INSPIRACJA / INSPIRATION

rok / year design

10B

oprawa / cover

KRAFT

znakowanie / marking method

łtczenie, szycie kreatywne / debossing, creative stitching

dodatek / add-on

M17B

projekt / design

kolor oprawy i nici do wyboru / cover colours and sewing threads to choose

DEDYKOWANE ZNAKOWANIE OPRAW, UKŁADY KALENDARZY I NOTESÓW ZAMIESZCZONE SĄ OD STRONY 77. / DEDICATED MARKING METHODS OF COVERS, LAYOUTS OF CALENDARS AND NOTEBOOKS ARE AVAILABLE FROM PAGE 77.

DURO



DURO

rok / year design

3

kolor / colour

szary / grey
czarny / black



DURO DUO - INSPIRACJA / INSPIRATION

rok / year design

M3

oprawa / cover

DURO + GUMA

łączenie opraw / cover combinations*

11

znakowanie / marking method

tłoczenie / debossing

dodatek / add-on

finochrom autorski / customised finochrome

DEDYKOWANE ZNAKOWANIE OPRAW, UKŁADY KALENDARZY I NOTESÓW ZAMIESZCZONE SĄ OD STRONY 77. / DEDICATED MARKING METHODS OF COVERS, LAYOUTS OF CALENDARS AND NOTEBOOKS ARE AVAILABLE FROM PAGE 77.

*WYBÓR DOSTĘPNYCH ŁĄCZEŃ OPRAW NA STRONIE 83. / SELECTION OF AVAILABLE TEMPLATES CONNECTIONS FOR COVERS ON THE PAGE 83.

IMAGE

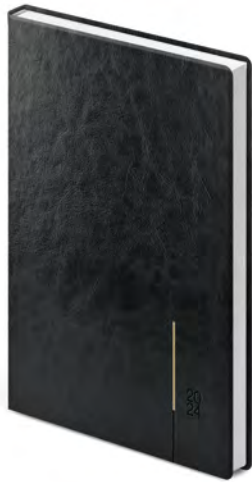

IMAGE

rok / year design

17A

kolor / colour

czarny / black

granatowy / dark blue

graftowy / graphite **NEW**

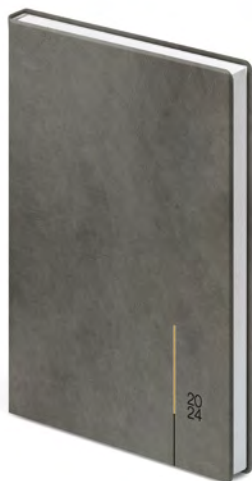
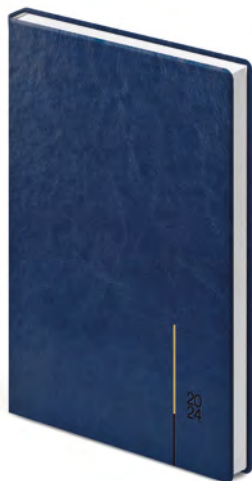

INSPIRACJA / INSPIRATION

rok / year design

7

oprawa / cover

IMAGE

znakowanie / marking method

grawer / engraving

dodatek / design*

M8 - 32 GB

*Z WYKLUCZENIEM FORMATU 504T. / DOES NOT APPLY TO BLOCK 504T.

FLESZ



FLESZ

rok / year design

21

kolor / colour

srebrny / silver

złoty / gold

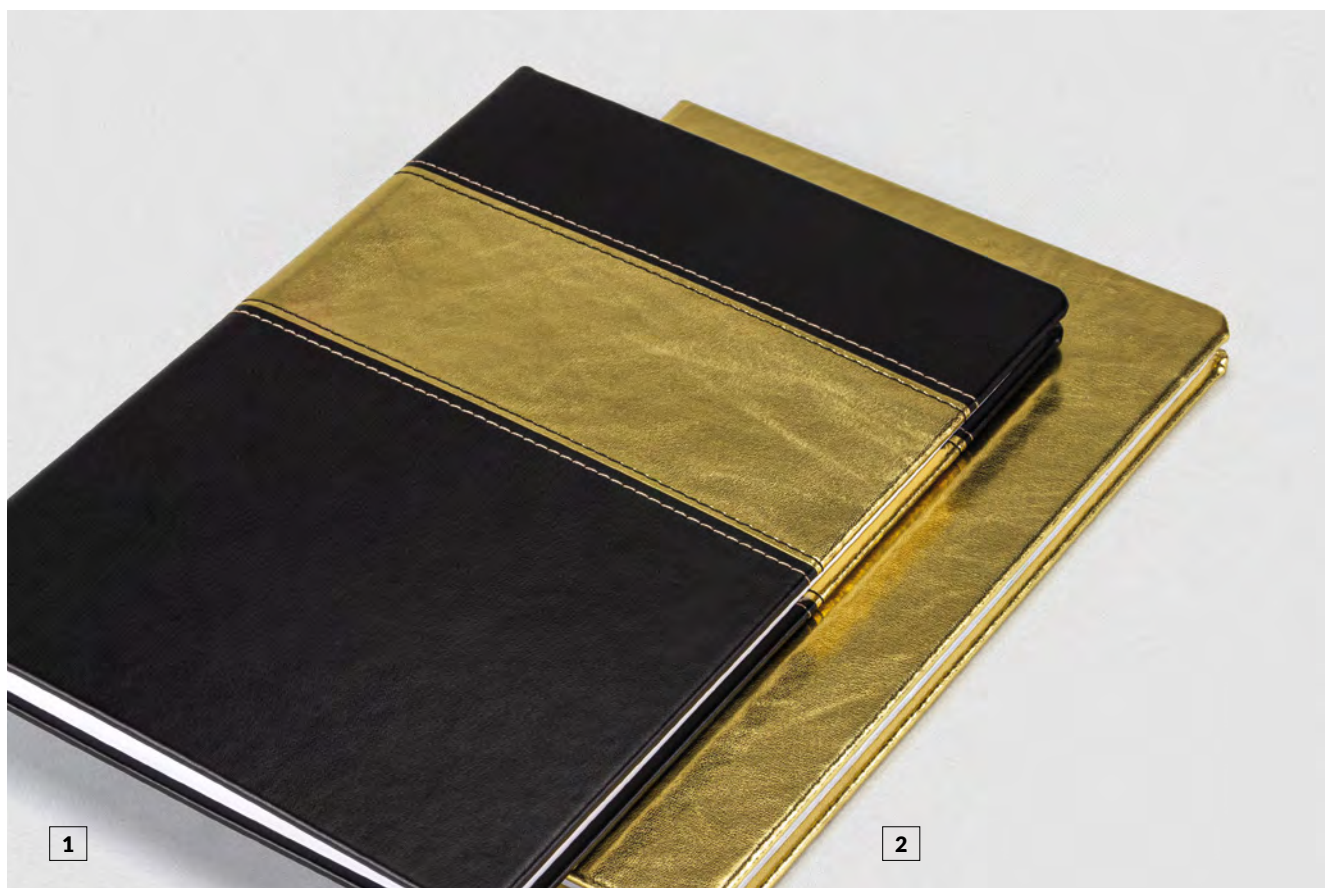

INSPIRACJA / INSPIRATION

rok / year design

9 – na grzbiecie oprawy / on the spine of the cover

oprawa / cover

1 – IDEO + FLESZ, 2 – FLESZ

łączenie opraw / cover combinations*

1 – 29

projekt / design

1 – kolor oprawy i nici do wyboru / cover colours and sewing threads to choose

DEDYKOWANE ZNAKOWANIE OPRAW, UKŁADY KALENDARZY I NOTESÓW ZAMIESZCZONE SĄ OD STRONY 77. / DEDICATED MARKING METHODS OF COVERS, LAYOUTS OF CALENDARS AND NOTEBOOKS ARE AVAILABLE FROM PAGE 77.

*WYBÓR DOSTĘPNYCH ŁĄCZEŃ OPRAW NA STRONIE 83. / SELECTION OF AVAILABLE TEMPLATES CONNECTIONS FOR COVERS ON THE PAGE 83.

IDEO

Druk UV / UV PRINT



IDEO

rok / year design

16A

kolor / colour

biały / white

seledynowy / willow-green

czerwony / red

granatowy / dark blue

czarny / black

szary / grey

jasny brąz / light brown **NEW**

bordowy / maroon **NEW**

DEDYKOWANE ZNAKOWANIE OPRAW, UKŁADY KALENDARZY I NOTESÓW ZAMIESZCZONE SĄ OD STRONY 77. / DEDICATED MARKING METHODS OF COVERS, LAYOUTS OF CALENDARS AND NOTEBOOKS ARE AVAILABLE FROM PAGE 77.

**PODKREŚL
SWÓJ STYL**

EXPRESS
YOUR STYLE



INSPIRACJA / INSPIRATION

rok / year design

1 - 20A, 2 - 23A

oprawa / cover

IDEO

znakowanie / marking method

tłoczenie / debossing

IDEO EXCLUSIVE

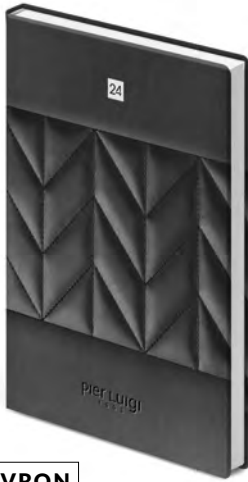

CHEVRON



HILLS



CARO



VENUS



SQUARES



CRYSTALS NEW

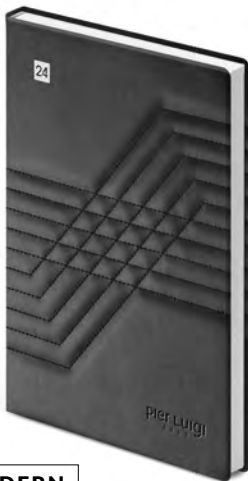

MODERN



VICTORY



DUNES NEW



OVAL NEW

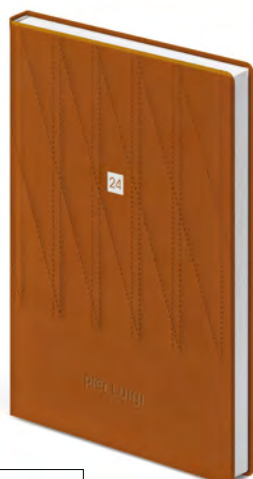

CHART NEW



IDEO EXCLUSIVE

rok / year design

oprawa / cover

znakowanie / marking method

projekt / design

M4

IDEO

łtłczenie, szycie kreatywne / debossing, creative stitching

kolor oprawy i nici do wyboru / cover colours and sewing threads to choose

ZESTAWY PREMIUM / PREMIUM SETS



PREMIUM CARO

kalendarz z papieru z kamienia /
stone paper calendar

511T / 512T / 516 / 509T

rok / year design

M4

oprawa / cover

IDEO

znakowanie / marking method

szycie kreatywne, 6 kryształów Swarovskiego / creative stitching, 6 Swarovski crystals

opakowanie / packaging

czarny papier barwiony w masie z przetłoczeniem, kalka z logo firmy /
black mass dyed paper with debossing, tracing paper with company logo

inne / other

wyklejka z papieru barwionego w masie / mass dyed endpaper



PREMIUM LOCK

kalendarz z papieru z kamienia /
stone paper calendar

rok / year design

oprawa / cover

znakowanie / marking method

dodatek / add-on

opakowanie / packaging

inne / other

511T / 512T / 516 / 509T

9 – na grzbiecie oprawy / on the spine of the cover

IDEO

grawer, obszycie / engraving, stitching

M11

czarny papier barwiony w masie z przetłoczeniem w kolorze srebrnym, kalka z logo firmy / black mass dyed paper with silver debossing, tracing paper with company logo

wyklejka z czarnego papieru barwionego w masie z tłoczonym logo na srebrno – wspólna matryca z opakowaniem / silver debossed logo on the both: the black mass dyed endpaper and the packaging

CARBON



CARBON

rok / year design

M3

kolor / colour

granatowy / dark blue

czarny / black

szary / grey

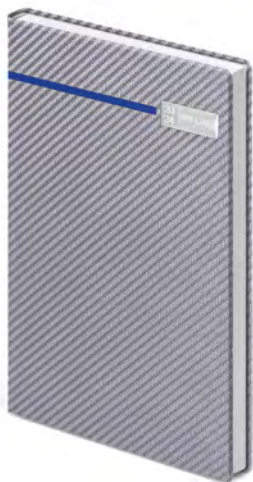

1



2



3

PRESTO - INSPIRACJA / INSPIRATION

rok / year design

1 4 - M2, 2 5 - 9 - na grzbiecie oprawy / on the spine of the cover, 3 - M3

oprawa / cover

CARBON + VIVELA

łączenie opraw / cover combinations* 21

znakowanie / marking method

1 2 4 5 - grawer / engraving

DEDYKOWANE ZNAKOWANIE OPRAW, UKŁADY KALENDARZY I NOTESÓW ZAMIESZCZONE SĄ OD STRONY 77. / DEDICATED MARKING METHODS OF COVERS, LAYOUTS OF CALENDARS AND NOTEBOOKS ARE AVAILABLE FROM PAGE 77.

*WYBÓR DOSTĘPNYCH ŁĄCZEŃ OPRAW NA STRONIE 83. / SELECTION OF AVAILABLE TEMPLATES CONNECTIONS FOR COVERS ON THE PAGE 83.

M1/M2
METALOWY
ELEMENT
MOŻE
TAK WIELE...

METAL
ELEMENT
HAS SO MUCH
POTENTIAL...



4

5

ITALIANO



ITALIANO

rok / year design

18

kolor / colour*

granatowy / dark blue

brązowy / brown

czarny / black



*ZRÓŻNICOWANY KOLOR SKÓRY I WYSTĘPUJĄCE NA NIEJ ZAGIĘCIA SĄ JEJ NATURALNYMI ELEMENTAMI I STANOWIĄ O JEJ WYJĄTKOWYM WYGLĄDZIE. TE ELEMENTY NIE PODLEGAJĄ REKLAMACJI. / THE VARIED COLOUR OF THE SKIN AND THE FOLDS ON IT ARE ITS NATURAL ELEMENTS AND DETERMINE ITS UNIQUE APPEARANCE. THESE ELEMENTS ARE NOT SUBJECT TO COMPLAINT.

**SKÓRA NATURALNA
NIEPRZEMIJAJĄCA
KLASYKA**

NATURAL LEATHER
THE LASTING
CLASSIC



INSPIRACJA / INSPIRATION

rok / year design	18
oprawa / cover	ITALIANO
znakowanie / marking method	łtczenie, obszycie / debossing, stitching
dodatek / add-on	M20A

DEDYKOWANE ZNAKOWANIE OPRAW, UKŁADY KALENDARZY I NOTESÓW ZAMIESZCZONE SĄ OD STRONY 77. / DEDICATED MARKING METHODS OF COVERS, LAYOUTS OF CALENDARS AND NOTEBOOKS ARE AVAILABLE FROM PAGE 77.

PATKI / SYNTHETIC LEATHER TABS

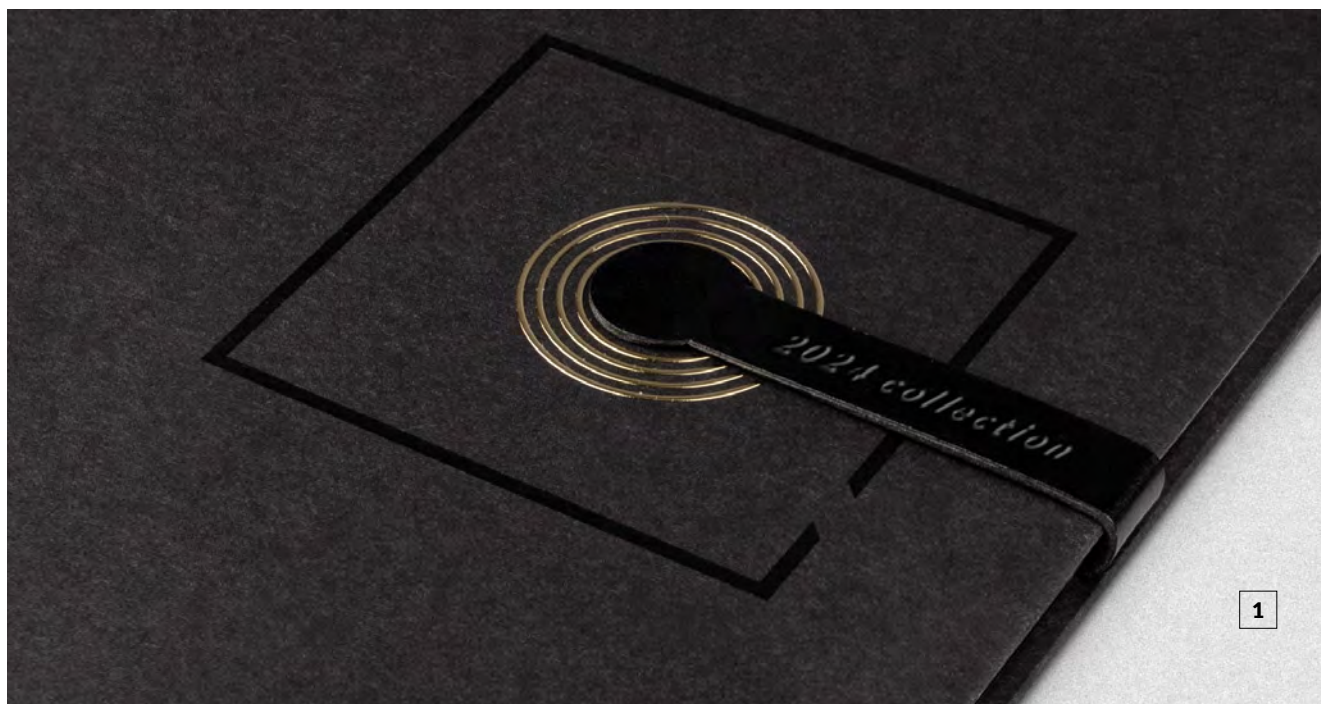

INSPIRACJA / INSPIRATION

oprawa / cover*

1 - NATURA, **2** - IDEO

znakowanie / marking method

1 - druk, tłoczenie folią, tłoczenie na patce /
print, foil stamping, debossing on the synthetic leather tab

dodatek / add-on**

1 - patka MINI / MINI synthetic leather tab
2 - patka MAXI / MAXI synthetic leather tab

*RODZAJ I KOLOR OPRAWY DO WYBORU. / TYPE AND COLOUR OF THE COVER MATERIAL ACCORDING TO YOUR CHOICE.

** RODZAJ I KOLOR OPRAWY DO WYBORU Z WYKLUCZENIEM OPRAW PAPIEROWYCH I rPET. / TYPE AND COLOUR OF THE COVER MATERIAL ACCORDING TO YOUR CHOICE, EXCLUDING PAPER AND rPET COVERS.

**TWOJE
NOTATKI
BEZPIECZNIE
ZAMKNIĘTE**

YOUR NOTES
SAFELY LOCKED

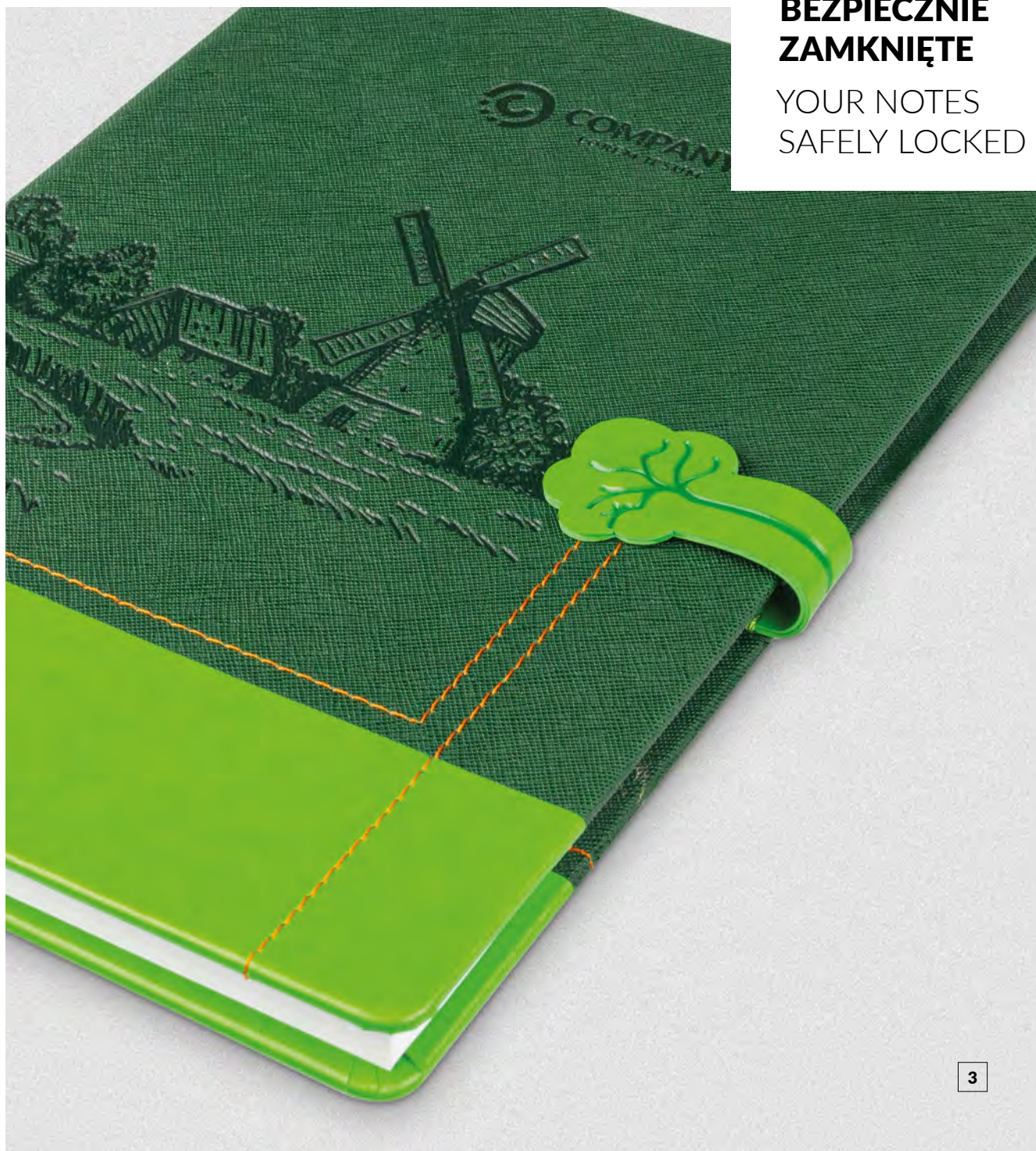

3

INSPIRACJA / INSPIRATION

oprawa / cover*

VIVELA + CROSS

łączenie opraw / cover combinations*** 9

znakowanie / marking method

łtłczenie wielkoformatowe, łtłczenie na patce, szycie kreatywne /
large format debossing, debossing on the synthetic leather tab, creative stitching

dodatek / add-on**

patka autorska / customised synthetic leather tab

***WYBÓR DOSTĘPNYCH ŁĄCZEŃ OPRAW NA STRONIE 83. / SELECTION OF AVAILABLE TEMPLATES CONNECTIONS FOR COVERS ON THE PAGE 83.

KALENDARZ BIURKOWY STOJĄCY I LEŻĄCY / LYING AND STANDING DESK CALENDAR



1 LEŻĄCY / LYING

INSPIRACJA / INSPIRATION

kalendarz / calendar

leżący / lying

rok / year design

2B

oprawa / cover*

CANVAS

znakowanie / marking method

tłoczenie / debossing

DEDYKOWANE ZNAKOWANIE OPRAW, UKŁADY KALENDARZY I NOTESÓW ZAMIESZCZONE SĄ OD STRONY 77. / DEDICATED MARKING METHODS OF COVERS, LAYOUTS OF CALENDARS AND NOTEBOOKS ARE AVAILABLE FROM PAGE 77.

**PLAN
TYGODNIA
W ZASIĘGU
WZROKU**

WEEKLY PLAN
WITHIN VIEW



2

STOJĄCY / STANDING

INSPIRACJA / INSPIRATION

kalendarz / calendar

stojący / standing

rok / year design

2B

oprawa / cover*

VIVELA

znakowanie / marking method

łtloczenie / debossing

*RODZAJ I KOLOR OPRAWY DO WYBORU Z WYKLUCZENIEM rPET. / TYPE AND COLOUR OF THE COVER MATERIAL ACCORDING TO YOUR CHOICE, EXCLUDING rPET COVERS.

OPAKOWANIA / PACKAGINGS

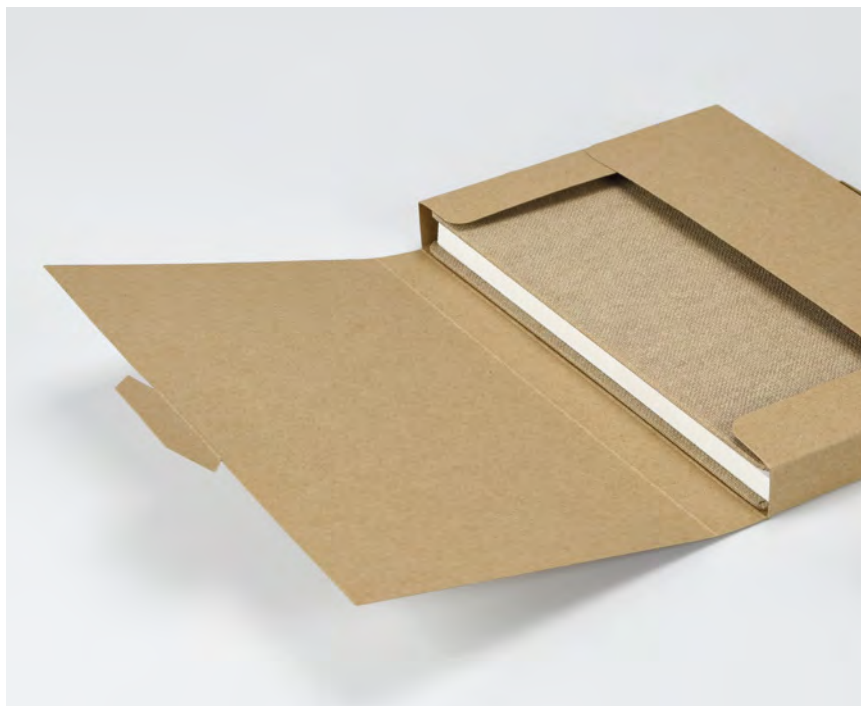

PUDEŁKO KOPERTOWE / ENVELOPE BOX PUDEŁKO WIECZKOWE / BOX WITH A LID

wymiar / size

pod każdy format z wykluczeniem 504T, notes A6 /
for any format except 504T, A6 notebook

materiał / material

papier barwiony w masie – czarny lub papier kraftowy /
mass dyed paper – black or kraft paper

znakowanie / marking method

łoczenie folią, sitodruk / foil stamping, silk-screen

**ZRÓB
PIERWSZE
WRAŻENIE**

MAKE A FIRST
IMPRESSION



PUDEŁKO ZASUWANE / SLIDING BOX

wymiar / size pod każdy format z wykluczeniem 504T, notes A6 /
for any format except 504T, A6 notebook

materiał / material* papier barwiony w masie lub papier kraftowy /
mass dyed paper or kraft paper

znakowanie / marking method tłoczenie folią, sitodruk / foil stamping, silk-screen

*DOSTĘPNE KOLORY NA STR. 75. / AVAILABLE COLORS ON PAGE 75.



DODATKI / ADD-ONS



GUMKA POZIOMA OKRĄGŁA 1,7 mm / 1,7 mm ROUND HORIZONTAL ELASTIC BAND*

*MONTAŻ GUMKI OKRĄGŁEJ NA GRZBIECIE TYLKO NA TWARDEJ OPRAWIE Z WYKLUCZENIEM OPRAW PAPIEROWYCH, QUERK I FORMATU 504T. / FITTING THE ROUND BAND ONLY ON A HARDCOVER EXCLUDING PAPER COVERS, QUERK AND 504T FORMAT.



GUMKA GRZBIETOWA
Z MIEJSCEM NA DŁUGOPIS /
SPINE ELASTIC PEN HOLDER



GUMKA POZIOMA PŁASKA 10 mm Z MIEJSCEM NA DŁUGOPIS /
10 mm FLAT HORIZONTAL ELASTIC BAND WITH A LOOP

WZÓR UŻYTKOWY - URZĄD PATENTOWY RP. / UTILITY MODEL PATENT OFFICE OF THE REPUBLIC OF POLAND.

SZLUFKA NA DŁUGOPIS /
ELASTIC PEN HOLDER



























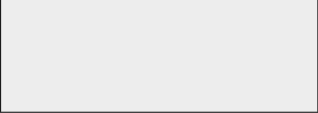

















GUMKA PIONOWA PŁASKA
10 mm / 10 mm FLAT
VERTICAL ELASTIC BAND



SPOSÓB MONTOWANIA GUMKI NA TYLE OKŁADKI. /
WAY OF ASSEMBLING THE ELASTIC BAND ON
THE BACK COVER.

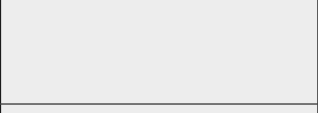

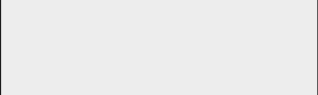
GUMKA PIONOWA PŁASKA
10 mm + M15 /
10 mm FLAT VERTICAL
ELASTIC BAND + M15

GUMKA PŁASKA FLAT ELASTIC BAND 10 mm	GUMKA OKRĄGŁA ROUND ELASTIC BAND 1,7 mm	TASIEMKA RIBBON 6 mm	KOLOR COLOUR
			czarny / black
			szary / grey
			brązowy / brown
			granatowy ciemny / navy blue
			granatowy jasny / light navy blue
			niebieski / blue
			żółty / yellow
			zielony / green
			seledynowy / willow-green
			bordowy / maroon NEW
			czerwony / red
			pomarańczowy / orange
			magenta / magenta
			beżowy / beige

DODATKI / ADD-ONS



M1*

BLASZKA ALUMINIOWA /
ALUMINUM PLATE

wymiar / size

40 × 14 mm

pole graweru / engraving area

38 × 12 mm



M2*

BLASZKA ALUMINIOWA
Z TŁOCZONYM ROKIEM /
ALUMINUM PLATE WITH
EMBOSSSED YEAR*

wymiar / size

40 × 14 mm

pole graweru / engraving area

26 × 12 mm



M3

ROK FINOCHROMOWY
PRZYKLEJANY DO OPRAWY /
FINOCHROME YEAR
STICKED TO COVER

wymiar / size

41 × 8,5 mm



M4

ROK FINOCHROMOWY
PRZYKLEJANY DO OPRAWY /
FINOCHROME YEAR
STICKED TO COVER

wymiar / size

10 × 10 mm



M8

PENDRIVE 32 GB
MOCOWANY W OPRAWIE /
32 GB FLASH DRIVE
HOLDER IN THE COVER

wymiar / size

34 × 11 mm

pole graweru / engraving area

28 × 8 mm



M15

BLASZKA METALOWA
(SREBRNA MATOWA)
MOCOWANA NA GUMCE
10 mm / RECTANGULAR
(SILVER MATTE) METAL
PLATE ON 10 mm ELASTIC
BAND

wymiar / size

45 × 14 mm

pole graweru / engraving area

34 × 12 mm

*MONTAŻ 10 mm OD BRZEGU OPRAWY. / MOUNTING 10 mm FROM THE EDGE OF COVER.



M11**
 ZAPINKA METALOWA
 (SREBRNA MATOWA)
 MOCOWANA NA NIT
 Z METALOWYM ZAWIASEM
 ZAMYKANYM NA MAGNES /
 METAL CLASP
 (SILVER MATTE) FIXED
 WITH A METAL HINGE,
 CLOSING WITH MAGNETS

wymiar / size

32 × 12 mm

pole graweru / engraving area

28 × 8 mm



M17C

KÓŁKO FINOCHROMOWE
 MIEDZIANE, PRZYKLEJANE
 DO OPRAWY / COPPER
 FINOCHROME DOT STICKED
 TO COVER

wymiar / size

5 × 5 mm



M17B

KÓŁKO FINOCHROMOWE
 SREBRNE, PRZYKLEJANE
 DO OPRAWY / SILVER
 FINOCHROME DOT STICKED
 TO COVER

wymiar / size

5 × 5 mm

**DOSTĘPNE W UKŁADZIE DZIENNYM I TYGODNIOWYM W KALENDARZACH I NOTESACH. / AVAILABLE FOR DAILY CALENDARS, WEEKLY CALENDARS AND NOTEBOOKS.

DODATKI / ADD-ONS



M18A

OKRĄG FINOCHROMOWY
ZŁOTY, PRZYKLEJANY
DO OPRAWY / GOLDEN
FINOCHROME CIRCLE
STICKED TO COVER

wymiar / size

23 × 23 mm



M18B

OKRĄG FINOCHROMOWY
SREBRNY, PRZYKLEJANY
DO OPRAWY / SILVER
FINOCHROME CIRCLE
STICKED TO COVER

wymiar / size

23 × 23 mm

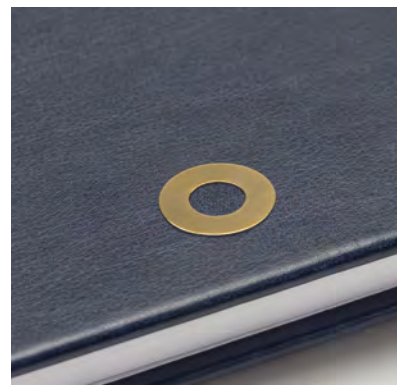

M19

OKRĄG FINOCHROMOWY
ZŁOTY, PRZYKLEJANY
DO OPRAWY / GOLDEN
FINOCHROME CIRCLE
STICKED TO COVER

wymiar / size

16 × 16 mm



M20A

LINIA FINOCHROMOWA
ZŁOTA PRZYKLEJANA
DO OPRAWY / GOLDEN
FINOCHROME LINE DOT
STICKED TO COVER

wymiar / size

0,9 × 45 mm



M20B

LINIA FINOCHROMOWA
SREBRNA PRZYKLEJANA
DO OPRAWY / SILVER
FINOCHROME LINE DOT
STICKED TO COVER

wymiar / size

0,9 × 45 mm

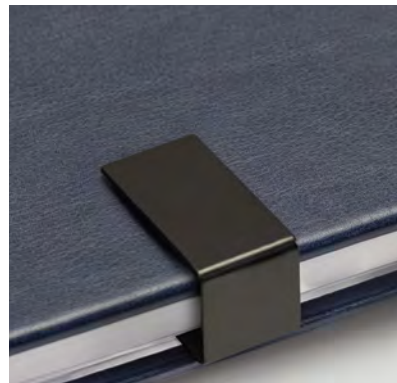

M16*

ZASUWKA METALOWA
(CZARNA MAT.)
MOCOWANA NA TYLNEJ
OPRAWIE Z KOPERTĄ /
METAL HASP (BLACK MAT)
MOUNTED ON THE BACK
COVER WITH ENVELOPE

wymiar / size

30 × 15 mm

pole graweru / engraving area

27 × 12 mm

*DOSTĘPNE W UKŁADZIE DZIENNYM I TYGODNIOWYM W KALENDARZACH I NOTESACH. / AVAILABLE FOR DAILY CALENDARS, WEEKLY CALENDARS AND NOTEBOOKS.



PATKA MINI**

MINI SYNTHETIC LEATHER TAB

ZAMYKANA NA MAGNES,
MAGNES UKRYTY W OPRAWIE /
WITH MAGNETIC CLOSURE,
MAGNET HIDDEN IN THE FRAME



PATKA MAXI**

MAXI SYNTHETIC LEATHER TAB

ZAMYKANA NA MAGNES
Z MIEJSCEM NA DŁUGOPIS,
MAGNES UKRYTY
W OPRAWIE /
WITH MAGNETIC CLOSURE
AND PEN HOLDER. MAGNET
HIDDEN IN THE FRAME



M21

BLASZKA ALUMINIOWA
POD PERSONALIZACJĘ /
ALUMINIUM PLATE
FOR PERSONALISATION

wymiar / size

70 × 8 mm



PERSONALIZACJA

GRAWEROWANA (wg projektu) /
ENGRAVED PERSONALISATION
(according to design)

font rekomendowany /
recommended font

VERDANA Regular min. 14 pkt /
min 14 pkt. VERDANA REGULAR

**Z WYKŁUCZENIEM OPRAW PAPIEROWYCH I rPET. / EXCLUDING PAPER AND rPET COVERS.

DODATKI / ADD-ONS



B1 NEW

OKRĄG BAMBUSOWY
Z ROKIEM 3D / BAMBOO
CIRCLE WITH 3D YEAR

wymiar / size

30 × 30 mm



N1 NEW

NASIONA SOSNY /
PINE SEEDS

wymiar / size

12 × 12 mm



G0072 NEW

DŁUGOPIS METALOWY
AUTOMAT. Z ELEMENTEM
KORKOWYM / AUTOMATIC
METAL PEN WITH KORK
ELEMENT

wymiar / size

144 × 10 mm

pole graweru / engraving area

50 × 5 mm



G0073 NEW

DŁUGOPIS METALOWY
AUTOMAT. Z ELEMENTEM
BAMBUSOWYM /
AUTOMATIC METAL PEN
WITH BAMBOO ELEMENT

wymiar / size

144 × 10 mm

pole graweru / engraving area

50 × 5 mm



inne / other

pokrycie soft, końcówka
dotykowa, wkład x-20 – 1 mm,
kolor tuszu niebieski, długość
pisania około 1000 m / barrel soft
finished, touch tip, x-20 – 1 mm
refill, blue ink color, writing length
approximately 1000 m



TRÓJKĄTNA KIESZONKA Z FOLII
TRIANGULAR FOIL POUCH

wymiar / size

80 × 80 mm
100 × 100 mm
120 × 120 mm



PROSTOKĄTNA KIESZONKA Z FOLII
FOIL BUSINESS CARD POCKET

wymiar / size

90 × 60 mm

wymiar wizytówki /
business card size

≤ 85 × 55 mm



TASIEMKA SUBLIMACYJNA
(wg projektu) /SUBLIMATION
RIBBON (according to design)

wymiar / size

8 mm
10 mm



druk / print

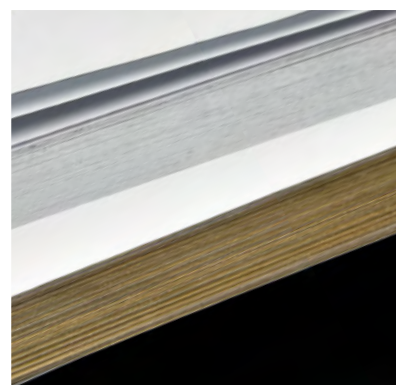

folia / foil

BARWIONE BRZEGI*
COLOURED EDGES

wymiar / size

pod każdy format / for any format

projekt barwienia brzegów /
coloured edges design

autorski / customised

zamówienie / order

min. 100 szt. / MOQ pcs.

*NIE DOTYCZY BLOKÓW Z PAPIERU Z KAMIENIA. MOŻLIWE BARWIENIE BRZEGÓW PRZEZ Druk WG CMYK, BĄDŹ USZLACHTNIENIE FOLIA ŻŁOTĄ LUB SREBRNĄ. / DOES NOT APPLY TO STONE PAPER BLOCKS. POSSIBLE COLOURING OF THE EDGES BY PRINTING IN CMYK OR FINISHING WITH GOLD OR SILVER FOIL.



**WYKLEJKA I KOPERTA
AUTORSKA**
CUSTOMISED
ENDPAPERS & ENVELOPE

wymiar / size

pod każdy format / for any format

materiał / material

papier ozdobny / decorative paper
papier barwiony w masie /
mass dyed paper
papier kraftowy / kraft paper
papier biały lub chamois /
white or ivory paper

znakowanie / marking method

druk / print

projekt / design

autorski / customised



**WKLEJKA WYCINANA
AUTORSKA**
CUSTOMISED INSERT PAGE

wymiar / size

pod każdy format / for any format

materiał / material

papier barwiony w masie /
mass dyed paper
papier kraftowy / kraft paper

znakowanie / marking method

druk / print

projekt / design

autorski / customised



KALKA

TRACING PAPER

wymiar / size

pod każdy format / for any format

znakowanie / marking method

druk jednostronny (wg projektu) /
one-sided printing (according
to design)

zastosowanie / application

obwoluta, wklejka / wrapper,
insert page



PAPIER KRAFT I BARWIONY W MASIE DO KOPERT, WYKLEJEK, WKLEJEK I OPAKOWAŃ

KRAFT AND MASS DYED PAPER
FOR ENVELOPES, ENDPAPERS,
INSERT PAGES AND PACKAGINGS

PROJEKT AUTORSKI / CUSTOMISED DESIGN



WYKLEJKA / ENDPAPER



KOPERTA / ENVELOPE



WKLEJKA / INSERT PAGE



BLOK AUTORSKI / CUSTOMISED BLOCK

ZNAKOWANIE OPRAW / COVERS MARKING METHODS

OPRAWA COVER	TŁOCZENIE DEBOSSING	TŁOCZENIE FOLIĄ FOIL DEBOSSING	GRAWER ENGRAVING	SZYCIE SEWING	DRUK PRINT
rPET					✓
QUERK					✓
RE-COVER				✓	✓
SAVANA	✓		✓	✓	✓
NATURA	✓	✓	✓	✓	✓
GAMBO	✓			✓	✓
CROSS	✓		✓	✓	✓
CANVAS	✓		✓	✓	✓
IDEO	✓	✓	✓	✓	✓
PIKO	✓		✓	✓	✓
GUMA	✓	✓	✓	✓	✓
IMAGE	✓	✓	✓	✓	✓
CARBON	✓		✓	✓	✓
COLORADO	✓	✓	✓	✓	✓
DURO	✓			✓	✓
KRAFT	✓	✓	✓	✓	✓
FLESZ	✓	✓	✓	✓	✓
VIVELA	✓	✓	✓	✓	✓
ITALIANO	✓	✓	✓		

ZESTAWIENIE ROKU / YEAR DESIGN



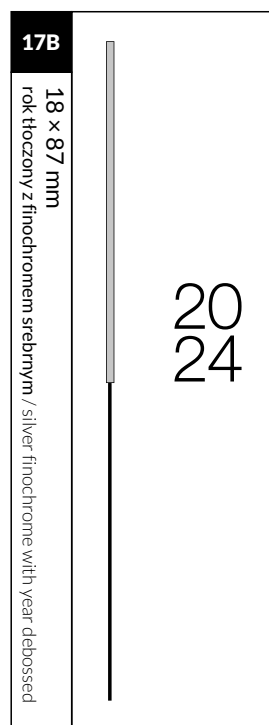
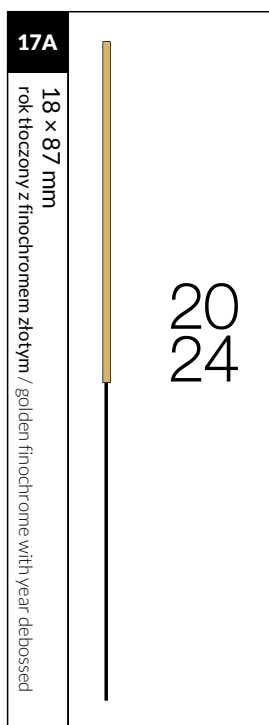
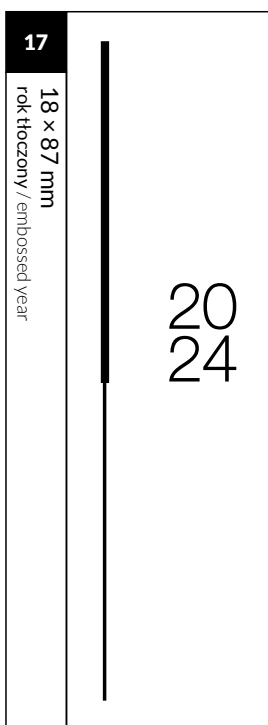
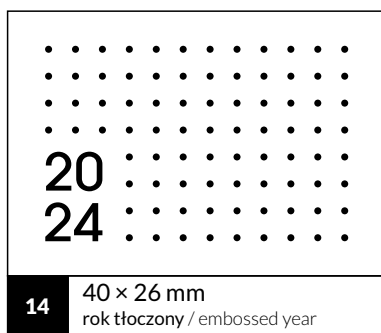
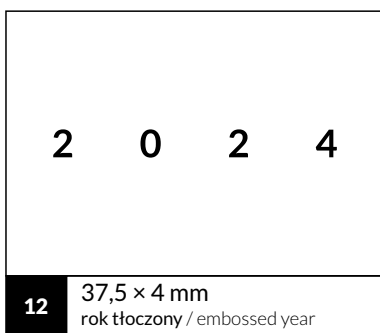
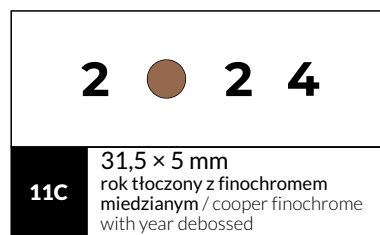
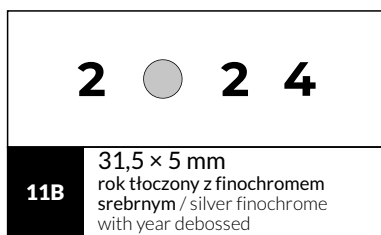
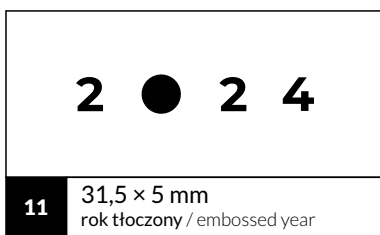
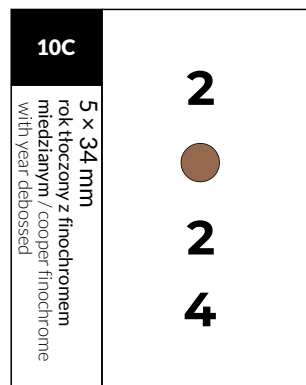
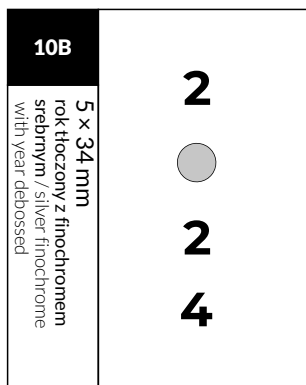
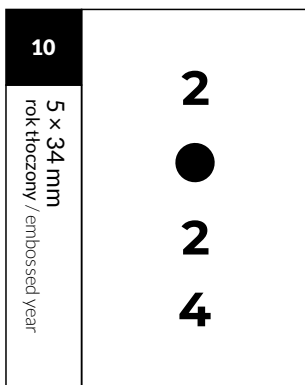

ZESTAWIENIE ROKU / YEAR DESIGN

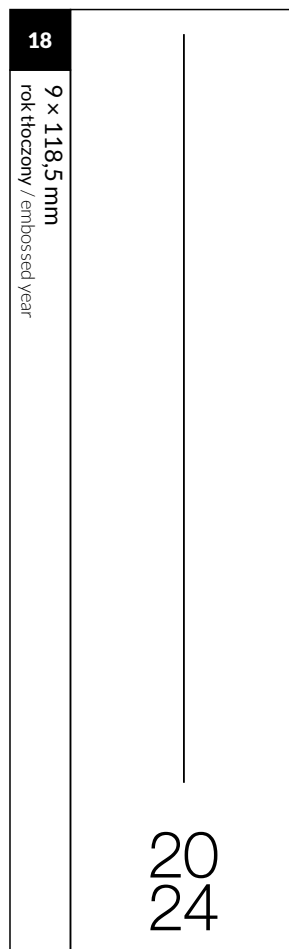
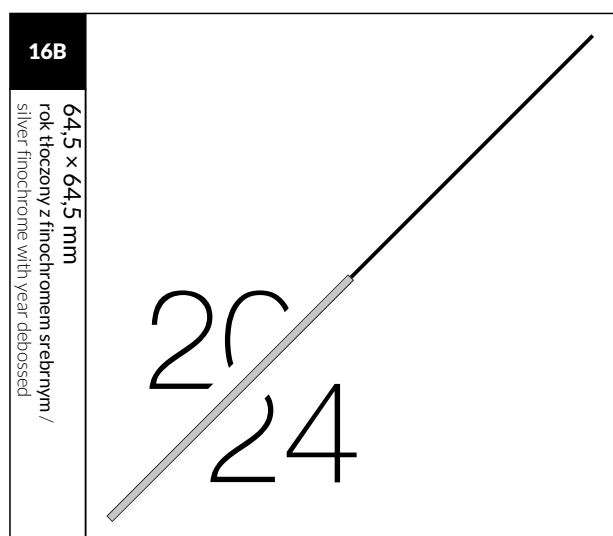
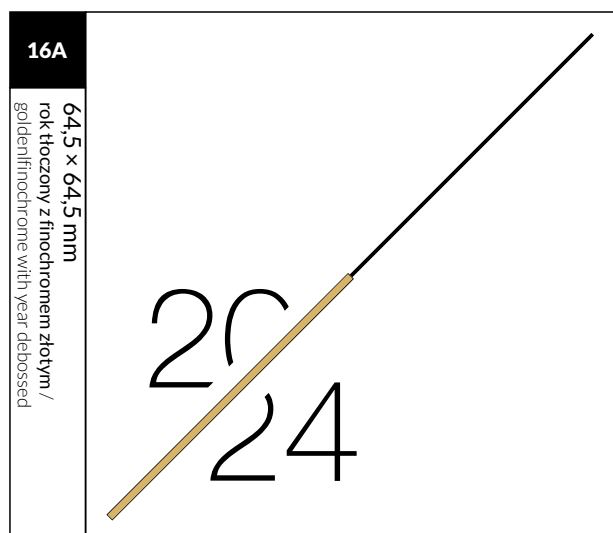
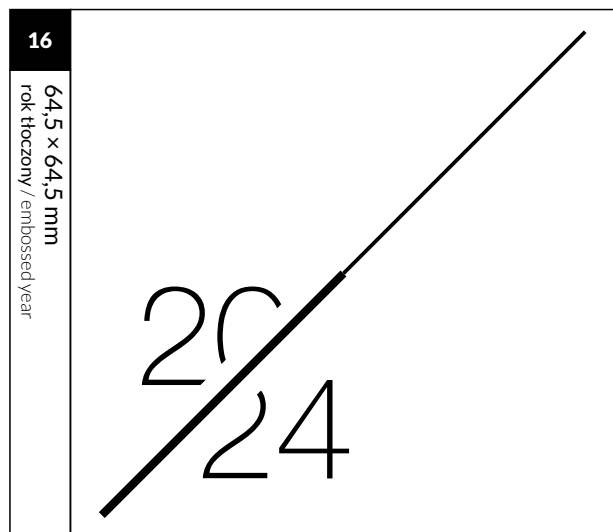

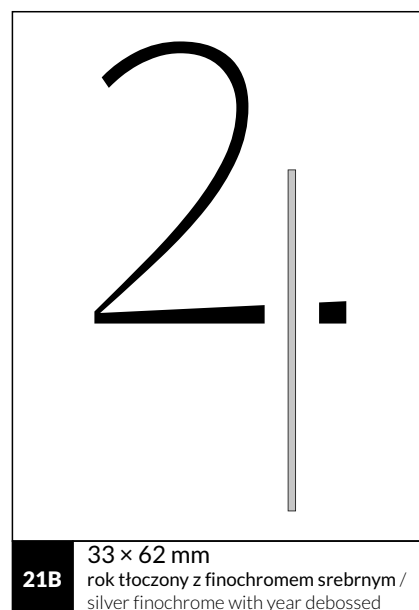
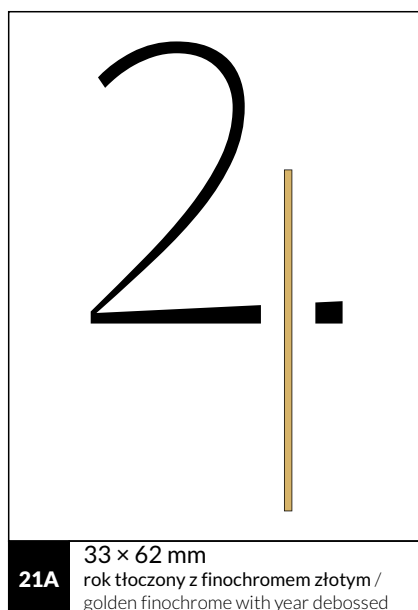
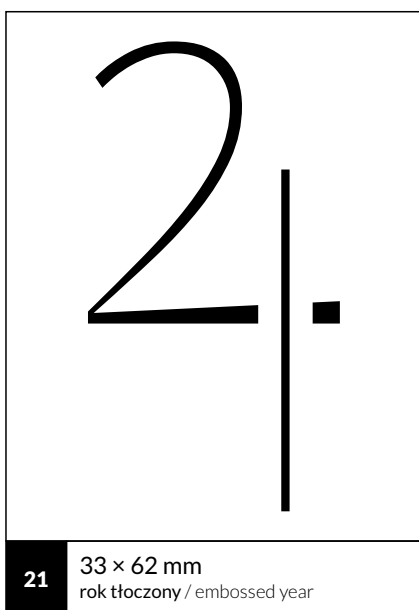
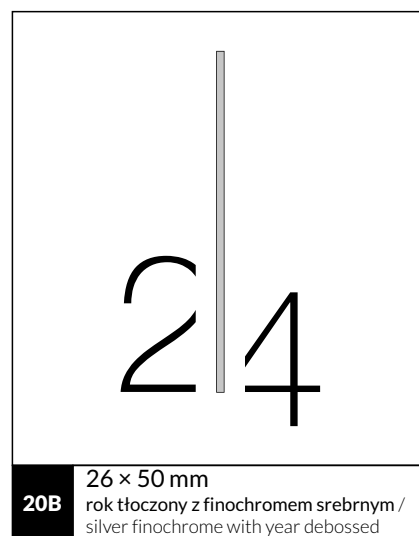
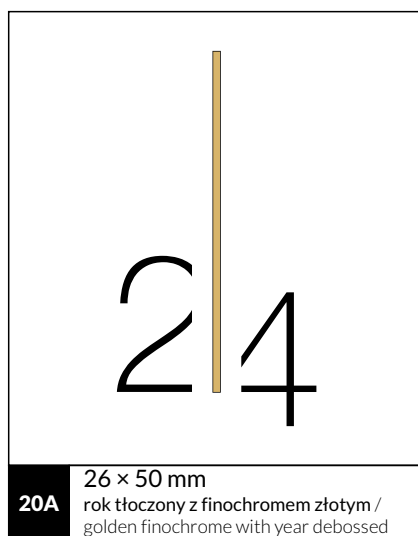
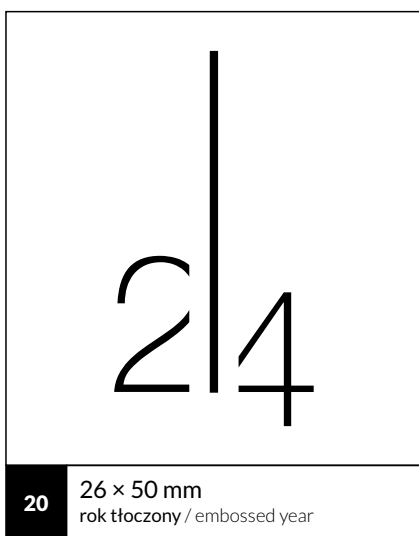
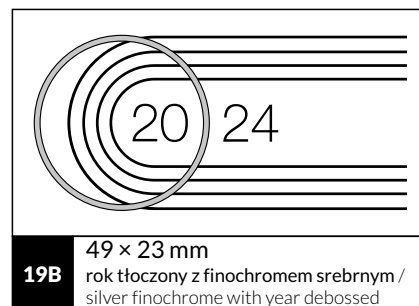
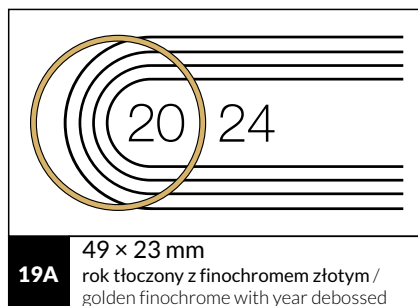
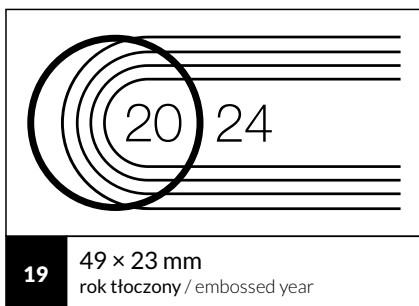

ZESTAWIENIE ROKU / YEAR DESIGN

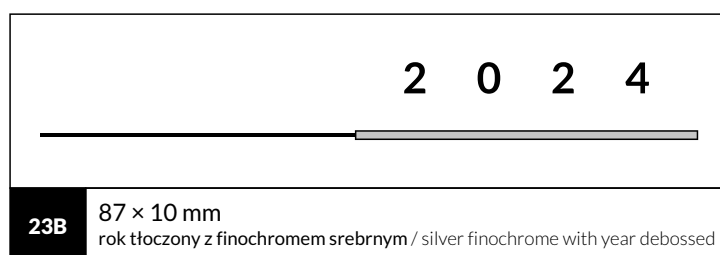
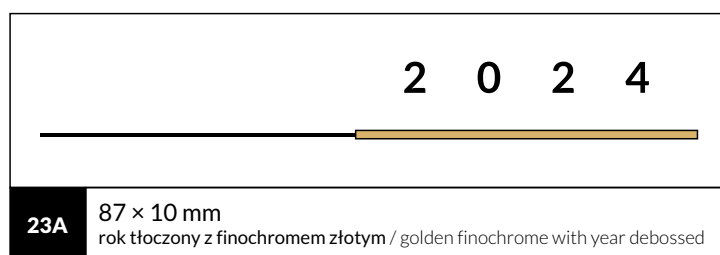
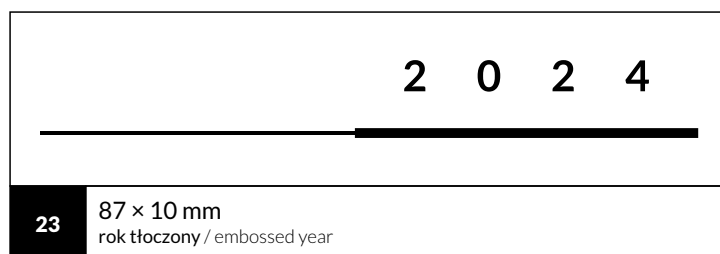
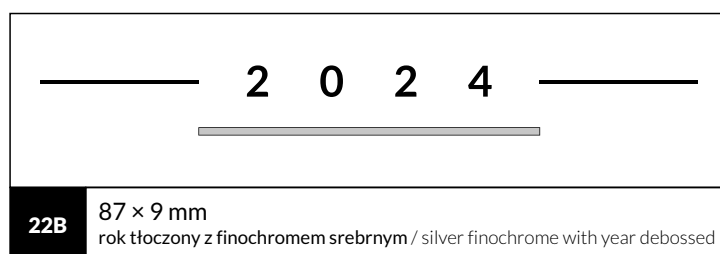
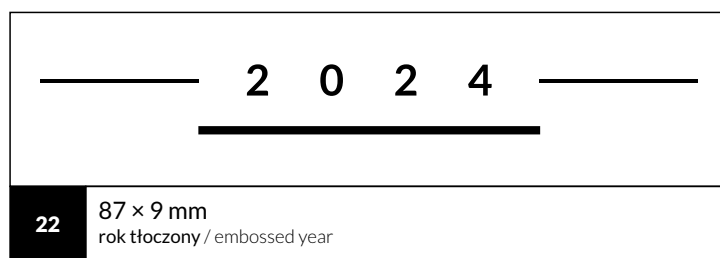

ŁĄCZENIE OPRAW / COVER COMBINATIONS

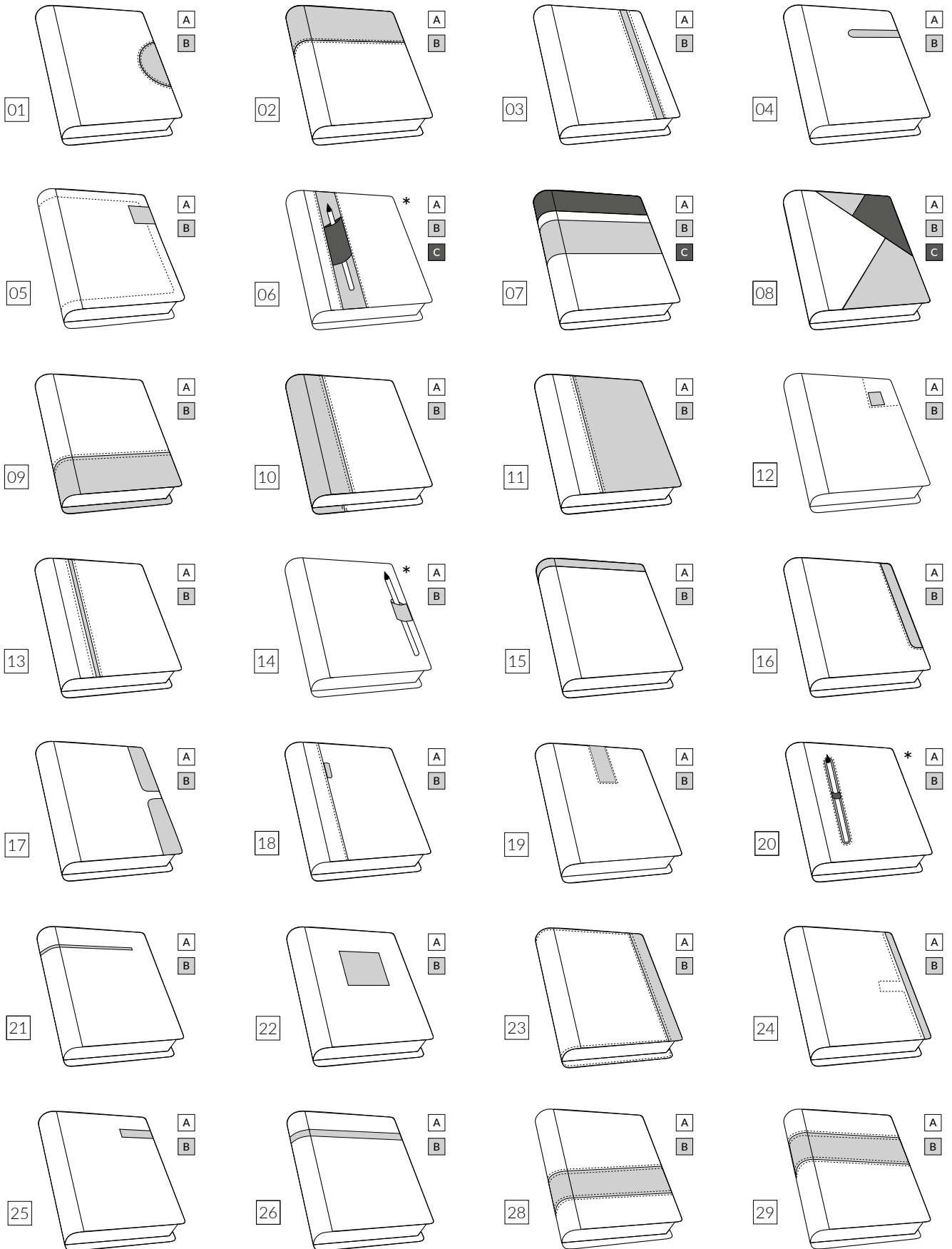

*SZLUFKA NA DŁUGOPIS. / ELASTIC PEN HOLDER.

PRZEDSTAWIONA NUMERACJA JEST WYKAZEM DOSTĘPNYCH ŁĄCZEŃ OPRAW Z WYKLUCZENIEM OPRAW PAPIEROWYCH I rPET. / THE NUMBERING SHOWN IS THE LIST OF THE COVER COMBINATIONS AVAILABLE, EXCLUDING PAPER AND rPET COVERS.

MATRYCE WIELKOFORMATOWE / LARGE FORMAT STAMPS

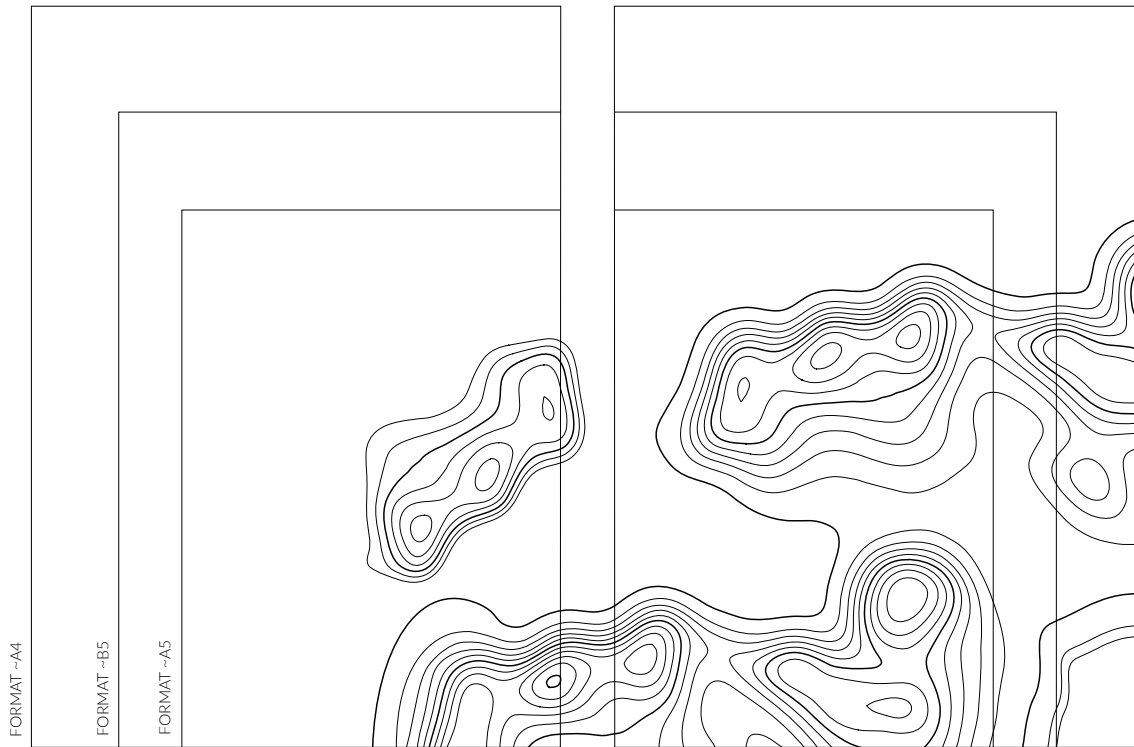

1

294 × 200 mm
wzór tłoczony / debossed pattern

SZEROKOŚĆ GRZBIETU ZALEŻNA OD ZAMAWIANEGO BLOKU. /
WIDTH OF THE SPINE DEPENDING ON THE ORDERED INNER BLOCK.

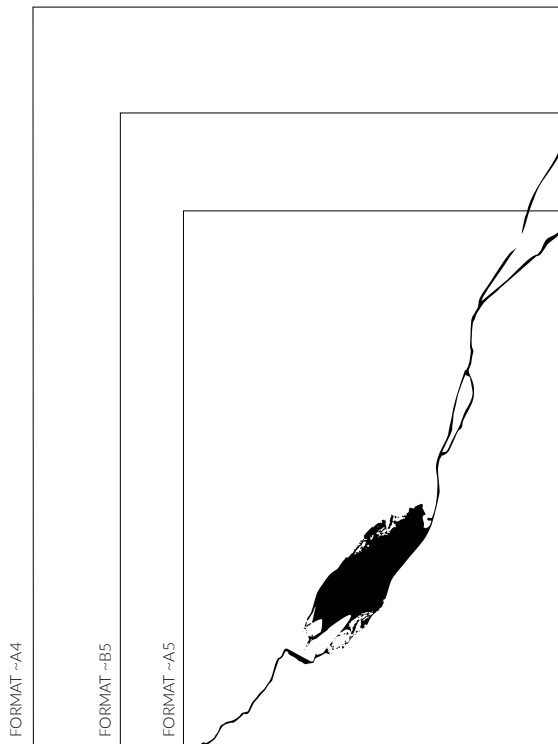

2

167 × 240 mm
wzór tłoczony / debossed pattern

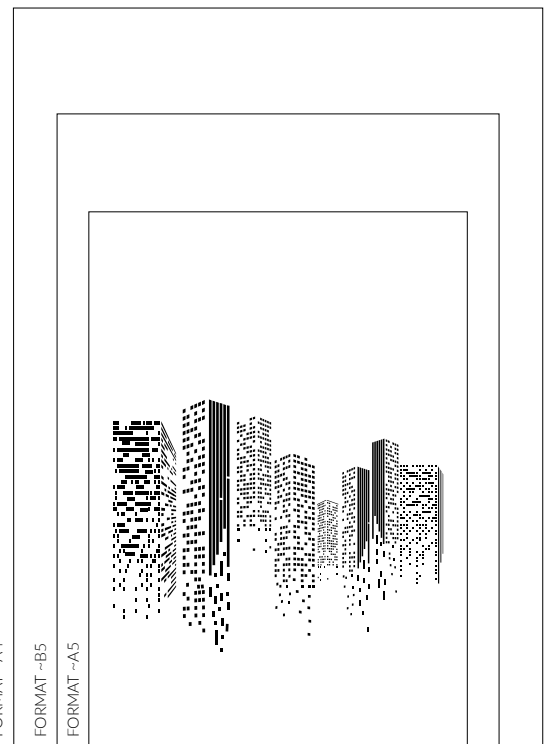

3

125 × 96 mm
wzór tłoczony / debossed pattern

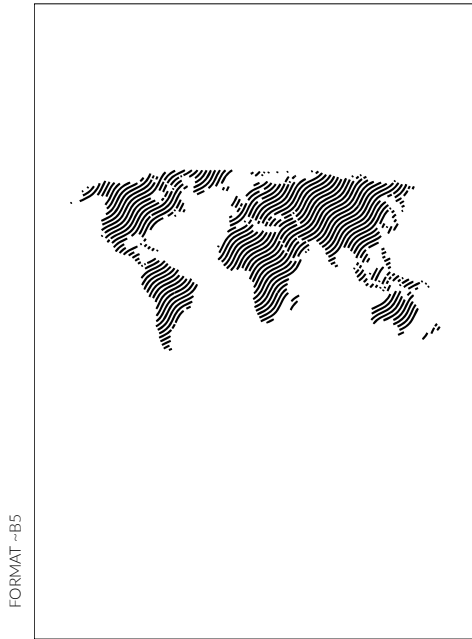

4 140 × 69 mm
wzór tłoczony / debossed pattern

MATRYCA DOSTOSOWANA DO FORMATÓW -A5 I -A4 /
STAMPING ADAPTED TO -A5 AND -A4 FORMATS

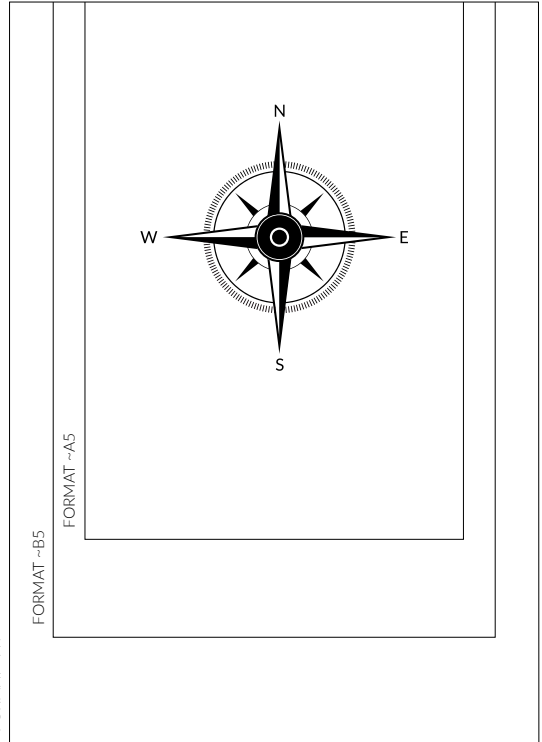

5 101 × 101 mm
wzór tłoczony / debossed pattern

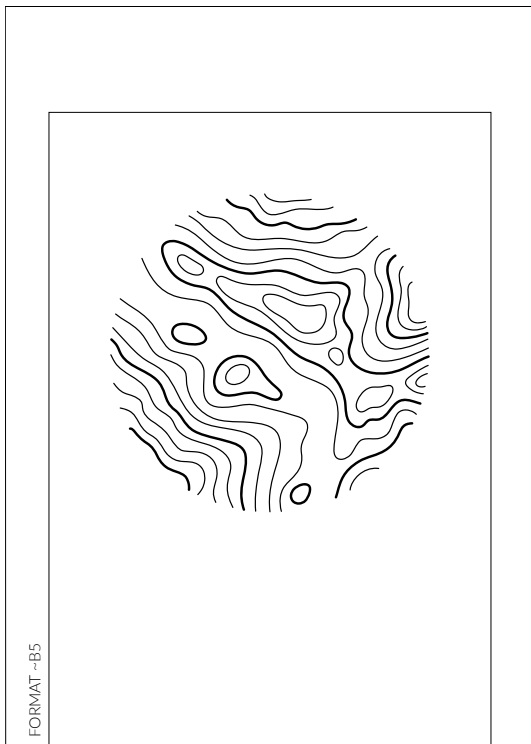

6 121 × 120 mm
wzór tłoczony / debossed pattern

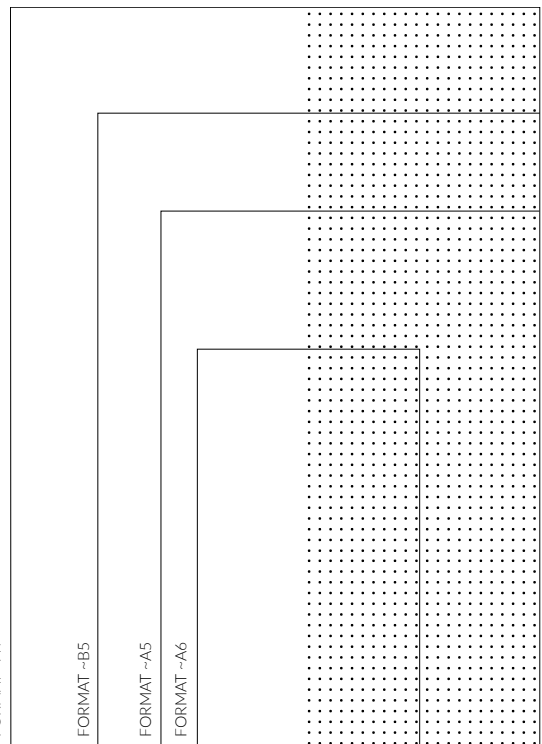

7 86 × 284 mm
wzór tłoczony / debossed pattern

PREZENTOWANE MATRYCE DO TŁOCZEŃ WIELKOFORMATOWYCH MOGĄ ZOSTAĆ UŻYTE BEZPŁATNIE DO DOWOLNEGO ZAMÓWIENIA. W TAKIM PRZYPADKU KLIENT PONOSI KOSZT WYŁĄCZNIE SAMEJ USŁUGI TŁOCZENIA ZGODNIE Z OBOWIĄZUJĄCYM CENNIKIEM (BEZ KOSZTÓW MATRYCY). / PRESENTED STAMPING USED FOR THE LARGE FORMAT DEBOSSINGS CAN BE USED FREE OF CHARGE FOR ANY ORDER. IN THIS CASE, THE CUSTOMER PAYS ONLY THE COST OF THE STAMPING SERVICE IN ACCORDANCE WITH THE APPLICABLE PRICE LIST (WITHOUT THE COSTS OF THE STAMP).

KALENDARZ / CALENDAR		501D	503D	508D	REGISTRY / INDEX		perforacja narożników corner perforation
format / format		200 × 280 mm ~A4	143 × 203 mm ~A5	162 × 240 mm ~B5	drukowane printed	wycinane tabbed	
ilość stron / pages		368	368	368			
papier biały / white paper druk / print	szaro-bordowy grey-maroon	✓	✓	✓	✓	✓	✓
	szaro-granatowy grey-dark blue	✓	✓	✓	✓	✓	✓
	szaro-grafitowy grey-graphite						
papier chamois/ ivory paper druk / print	szaro-bordowy grey-maroon	✓	✓	✓	✓	✓	✓
	szaro-granatowy grey-dark blue	✓	✓	✓	✓	✓	✓
	szaro-grafitowy grey-graphite						
papier z recyklingu / recycled paper druk / print	szaro-grafitowy grey-graphite		✓		✓		
papier z trawy / grass paper druk / print	szaro-grafitowy grey-graphite						
papier z kamienia / stone paper druk / print	szaro-grafitowy grey-graphite						
język / language		PL GB DE IT UA					
dane personalne / personal data		✓	✓	✓			
licznik dni / day counter		✓	✓	✓			
numeracja tygodni / week numbering		✓	✓	✓			
karta planowania celów / goal planning sheet		✓	✓	✓			
święta międzynarodowe / international holidays		✓	✓	✓			
kalendarz skrócony / shortened calendar 2023-2025		✓	✓	✓			
planer roczny / annual planner		✓	✓	✓			
planer miesięczny / monthly planner		✓	✓	✓			
kalendarz roczny / annual calendar 2024		✓	✓	✓			
imieniny / name day		✓	✓	✓			
aforyzmy / aphorisms		✓	✓	✓			
oświadczenie drogowe / accident statement		✓	✓	✓			
notes / notebook		✓	✓	✓			
mapy / maps							

BLOKI KALENDARZY DZIENNYCH / DAILY CALENDARS LAYOUTS

506D

162+204

10 Poniedziałek

CZERWIEC

June, Juni, Giugno, ҆ебзезь

TYDZIEŃ 24

Bogumiła, Malgorzaty

Week, Woche, Settimana, Тиждзень

7 _____

8 _____

9 _____

10 _____

11 _____

12 _____

13 _____

14 _____

15 _____

16 _____

17 _____

18 _____

19 _____

20 _____

21 _____

22 _____

23 _____

24 _____

25 _____

26 _____

27 _____

28 _____

29 _____

30 _____

31 _____

Wygrzwyj bez pycny, przogrzywyj bez urazy.
Bruce Lee

163+203

11 Wtorek

CZERWIEC

June, Juni, Giugno, ҆ебзезь

TYDZIEŃ 24

Barnaby, Feliksa

Week, Woche, Settimana, Тиждзень

7 _____

8 _____

9 _____

10 _____

11 _____

12 _____

13 _____

14 _____

15 _____

16 _____

17 _____

18 _____

19 _____

20 _____

21 _____

22 _____

23 _____

24 _____

25 _____

26 _____

27 _____

28 _____

29 _____

30 _____

31 _____

Krytyka jest czymś, czego możemy łatwo uniknąć
nie mówiąc nic, nie robiąc nic i będąc nikim.
Aristoteles

	STYCZEŃ	LUTY	MARZEC	KWIECIEŃ	MAJ	CZERWIEC
ni	1 2 3 4 5	6 7 8 9	10 11 12 13	14 15 16 17 18	19 20 21 22	23 24 25 26
pn	6 13 20 27	4 11 18 25	1 8 15 22 29	5 12 19 26	2 9 16 23	3 10 17 24
wt	7 14 21 28	5 12 19 26	2 9 16 23 30	7 14 21 28	4 11 18 25	5 12 19 26
śr	8 15 22 29	6 13 20 27	3 10 17 24	1 8 15 22 29	5 12 19 26	6 13 20 27
cz	9 16 23 30	7 14 21 28	4 11 18 25	2 9 16 23 30	6 13 20 27	7 14 21 28
pt	10 17 24 31	8 15 22 29	5 12 19 26	3 10 17 24 31	7 14 21 28	8 15 22 29
so	11 18 25	9 16 23 30	6 13 20 27	4 11 18 25	1 8 15 22 29	2 9 16 23 30
nd	12 19 26	10 17 24 31	7 14 21 28	5 12 19 26	2 9 16 23 30	3 10 17 24

	LIPIEC	SIERPIEŃ	WRZESIEŃ	PAŹDZIERNIK	LISTOPAD	GRUDZIEŃ
ni	1 7 14 21 28	4 11 18 25	2 9 16 23 30	40 41 42 43 44	44 45 46 47 48	48 49 50 51 52 1
pn	2 9 16 23 30	5 12 19 26	3 10 17 24 31	1 8 15 22 29	4 11 18 25	2 9 16 23 30
wt	3 10 17 24 31	6 13 20 27	4 11 18 25	2 9 16 23 30	5 12 19 26	3 10 17 24 31
śr	4 11 18 25	7 14 21 28	5 12 19 26	3 10 17 24 31	6 13 20 27	4 11 18 25
cz	5 12 19 26	8 15 22 29	6 13 20 27	4 11 18 25	1 8 15 22 29	6 13 20 27
pt	6 13 20 27	9 16 23 30	7 14 21 28	5 12 19 26	2 9 16 23 30	7 14 21 28
so	7 14 21 28	10 17 24 31	8 15 22 29	6 13 20 27	3 10 17 24	1 8 15 22 29

510D

5+361

5 Friday

JANUARY

1

7 _____

8 _____

9 _____

10 _____

11 _____

12 _____

13 _____

14 _____

15 _____

16 _____

17 _____

18 _____

19 _____

20 _____

21 _____

22 _____

23 _____

24 _____

25 _____

26 _____

27 _____

28 _____

29 _____

30 _____

31 _____

6+360

6 Saturday

JANUARY

1

7 _____

8 _____

9 _____

10 _____

11 _____

12 _____

13 _____

14 _____

15 _____

16 _____

17 _____

18 _____

19 _____

20 _____

21 _____

22 _____

23 _____

24 _____

25 _____

26 _____

27 _____

28 _____

29 _____

30 _____

31 _____

	I	II	III	IV	V	VI
w	1 2 3 4 5	6 7 8 9	10 11 12 13	14 15 16 17 18	19 20 21 22	23 24 25 26
mo	1 8 15 22 29	5 12 19 26	4 11 18 25	1 8 15 22 29	6 13 20 27	3 10 17 24
tu	2 9 16 23 30	6 13 20 27	5 12 19 26	2 9 16 23 30	7 14 21 28	4 11 18 25
we	3 10 17 24 31	7 14 21 28	6 13 20 27	3 10 17 24	1 8 15 22 29	5 12 19 26
th	4 11 18 25	1 8 15 22 29	7 14 21 28	4 11 18 25	2 9 16 23 30	6 13 20 27
fr	5 12 19 26	2 9 16 23	1 8 15 22 29	5 12 19 26	3 10 17 24 31	7 14 21 28
sa	6 13 20 27	3 10 17 24	2 9 16 23 30	6 13 20 27	4 11 18 25	1 8 15 22 29
su	7 14 21 28	4 11 18 25	3 10 17 24 31	7 14 21 28	5 12 19 26	2 9 16 23 30

	VII	VIII	IX	X	XI	XII
w	27 28 29 30 31	31 32 33 34 35	35 36 37 38 39 40	40 41 42 43 44	44 45 46 47 48	48 49 50 51 52 1
mo	1 8 15 22 29	5 12 19 26	2 9 16 23 30	7 14 21 28	4 11 18 25	2 9 16 23 30
tu	2 9 16 23 30	6 13 20 27	3 10 17 24	1 8 15 22 29	5 12 19 26	3 10 17 24 31
we	3 10 17 24 31	7 14 21 28	4 11 18 25	2 9 16 23 30	6 13 20 27	4 11 18 25
th	4 11 18 25	1 8 15 22 29	5 12 19 26	3 10 17 24 31	7 14 21 28	5 12 19 26
fr	5 12 19 26	2 9 16 23 30	6 13 20 27	4 11 18 25	1 8 15 22 29	6 13 20 27
sa	6 13 20 27	3 10 17 24 31	7 14 21 28	5 12 19 26	2 9 16 23 30	7 14 21 28
su	7 14 21 28	4 11 18 25	1 8 15 22 29	6 13 20 27	3 10 17 24	1 8 15 22 29

KALENDARZ / CALENDAR		506D	510D	REGISTRY / INDEX		perforacja narożników corner perforation
format / format		110 × 160 mm ~A6	143 × 203 mm ~A5	drukowane printed	wycinane tabbed	
ilość stron / pages		368	368			
papier biały / white paper druk / print	szaro-bordowy grey-maroon					
	szaro-granatowy grey-dark blue					
	szaro-grafitowy grey-graphite	✓	✓	✓		
papier chamois/ ivory paper druk / print	szaro-bordowy grey-maroon					
	szaro-granatowy grey-dark blue					
	szaro-grafitowy grey-graphite					
papier z recyklingu / recycled paper druk / print	szaro-grafitowy grey-graphite					
papier z trawy / grass paper druk / print	szaro-grafitowy grey-graphite					
papier z kamienia / stone paper druk / print	szaro-grafitowy grey-graphite					
język / language		PL GB DE IT UA	GB			
dane personalne / personal data		✓	✓			
licznik dni / day counter		✓	✓			
numeracja tygodni / week numbering		✓	✓			
karta planowania celów / goal planning sheet		✓	✓			
święta międzynarodowe / international holidays		✓	✓			
kalendarz skrócony / shortened calendar 2023-2025		✓	✓			
planer roczny / annual planner		✓	✓			
planer miesięczny / monthly planner		✓	✓			
kalendarz roczny / annual calendar 2024		✓	✓			
imieniny / name day		✓				
aforyzmy / aphorisms		✓				
oświadczenie drogowe / accident statement						
notes / notebook		✓	✓			
mapy / maps						

BLOKI KALENDARZY TYGODNIOWYCH / WEEKLY CALENDARS LAYOUTS

502T 507T

GRUDZIEŃ
December, Dezember, Dicembre, Еризынь

358+8 | **23** | **Poniedziałek**
Mo / Mo / Lu / Plr

359+7 | **24** | **Wtorek**
Tu / Di / Ma / Br

360+6 | **25** | **Środa**
We / Mi / Me / Cp

Wiktoria, Sławomy

WIGILIA BOŻEGO NARODZENIA
Adama, Ewy

BOŻE NARODZENIE
Eugenii, Anastazji

7 _____

8 _____

9 _____

10 _____

11 _____

12 _____

13 _____

14 _____

15 _____

16 _____

17 _____

18 _____

STYCZEŃ LUTY MARZEC KWIECIEŃ MAJ CZERWIEC

T	1 2 3 4 5	5 6 7 8 9	9 10 11 12 13	14 15 16 17 18	18 19 20 21 22	22 23 24 25 26
Wn	1 8 15 22 29	5 12 19 26	4 11 18 25	1 8 15 22 29	6 13 20 27	3 10 17 24
Wt	2 9 16 23 30	6 13 20 27	5 12 19 26	2 9 16 23 30	7 14 21 28	4 11 18 25
Śr	3 10 17 24 31	7 14 21 28	6 13 20 27	3 10 17 24	1 8 15 22 29	8 12 19 26
Cz	4 11 18 25	1 8 15 22 29	7 14 21 28	4 11 18 25	2 9 16 23 30	6 13 20 27
Pt	5 12 19 26	2 9 16 23	1 8 15 22 29	5 12 19 26	3 10 17 24 31	7 14 21 28
So	6 13 20 27	3 10 17 24	2 9 16 23 30	6 13 20 27	4 11 18 25	1 8 15 22 29
Nd	7 14 21 28	4 11 18 25	3 10 17 24 31	7 14 21 28	5 12 19 26	2 9 16 23 30

TYDZIEŃ 52
Week, Woche, Settimana, Тиждень

361+5 | **26** | **Czwartek**
Th / Do / Gi / Hr

362+4 | **27** | **Piątek**
Fr / Fr / Ve / Plr

363+3 | **28** | **Sobota**
Sa / Sa / Sa / Co

BOŻE NARODZENIE
Dionizego, Szczepana

NARODOWY DZIEŃ ZWYCIĘSKIEGO
POWSTANIA WIELKOPOLSKIEGO
Kosmy, Damiana

Cezarego, Teofila

7 _____

8 _____

9 _____

10 _____

11 _____

12 _____

13 _____

14 _____

15 _____

16 _____

17 _____

18 _____

364+2 | **29** | **Niedziela**
Su / So / Do / Hg

Dawida, Jonatana

Nie możesz kontrolować zachowania
innych, ale zawsze możesz wybrać
sposób, w jaki na nie reagujesz.
Roy T. Bennett

LIPIEC SIERPIEŃ WRZESIEŃ PAŹDZIERNIK LISTOPAD GRUDZIEŃ

T	27 28 29 30 31	31 32 33 34 35	35 36 37 38 39 40	40 41 42 43 44	44 45 46 47 48	48 49 50 51 52 1
Wn	1 8 15 22 29	5 12 19 26	2 9 16 23 30	7 14 21 28	4 11 18 25	2 9 16 23 30
Wt	2 9 16 23 30	6 13 20 27	3 10 17 24	1 8 15 22 29	5 12 19 26	3 10 17 24 31
Śr	3 10 17 24 31	7 14 21 28	4 11 18 25	2 9 16 23 30	6 13 20 27	4 11 18 25
Cz	4 11 18 25	1 8 15 22 29	5 12 19 26	3 10 17 24 31	7 14 21 28	5 12 19 26
Pt	5 12 19 26	2 9 16 23 30	6 13 20 27	4 11 18 25	1 8 15 22 29	6 13 20 27
So	6 13 20 27	3 10 17 24 31	7 14 21 28	5 12 19 26	2 9 16 23 30	7 14 21 28
Nd	7 14 21 28	4 11 18 25	1 8 15 22 29	6 13 20 27	3 10 17 24	1 8 15 22 29



KALENDARZ / CALENDAR		502T	507T	REGISTRY / INDEX		perforacja narożników corner perforation
format / format		208 × 260 mm ~A4	167 × 240 mm ~B5	drukowane printed	wycinane tabbed	
ilość stron / pages		160	160			
papier biały / white paper druk / print	szaro-bordowy grey-maroon	✓	✓	✓	✓	✓
	szaro-granatowy grey-dark blue	✓	✓	✓	✓	✓
	szaro-grafitowy grey-graphite					
papier chamois/ ivory paper druk / print	szaro-bordowy grey-maroon	✓	✓	✓	✓	✓
	szaro-granatowy grey-dark blue	✓	✓	✓	✓	✓
	szaro-grafitowy grey-graphite					
papier z recyklingu / recycled paper druk / print	szaro-grafitowy grey-graphite					
papier z trawy / grass paper druk / print	szaro-grafitowy grey-graphite		✓	✓		
papier z kamienia / stone paper druk / print	szaro-grafitowy grey-graphite					
język / language		PL GB DE IT UA				
dane personalne / personal data		✓	✓			
licznik dni / day counter		✓	✓			
numeracja tygodni / week numbering		✓	✓			
karta planowania celów / goal planning sheet		✓	✓			
święta międzynarodowe / international holidays		✓	✓			
kalendarz skrócony / shortened calendar 2023-2025		✓	✓			
planer roczny / annual planner		✓	✓			
planer miesięczny / monthly planner		✓	✓			
kalendarz roczny / annual calendar 2024		✓	✓			
imieniny / name day		✓	✓			
aforyzmy / aphorisms		✓	✓			
oświadczenie drogowe / accident statement		✓	✓			
notes / notebook		✓	✓			
mapy / maps						

KALENDARZ / CALENDAR		504T	REGISTRY / INDEX		
format / format		84 × 151 mm format kieszonkowy pocket-sized format	drukowane printed	wycinane tabbed	perforacja narożników corner perforation
ilość stron / pages		128			
papier biały / white paper druk / print	szaro-bordowy grey-maroon				
	szaro-granatowy grey-dark blue				
	szaro-grafitowy grey-graphite	✓	✓		
papier chamois/ ivory paper druk / print	szaro-bordowy grey-maroon				
	szaro-granatowy grey-dark blue				
	szaro-grafitowy grey-graphite	✓	✓		
papier z recyklingu / recycled paper druk / print	szaro-grafitowy grey-graphite				
papier z trawy / grass paper druk / print	szaro-grafitowy grey-graphite				
papier z kamienia / stone paper druk / print	szaro-grafitowy grey-graphite				
język / language		PL GB DE IT UA			
dane personalne / personal data		✓			
licznik dni / day counter					
numeracja tygodni / week numbering		✓			
karta planowania celów / goal planning sheet					
święta międzynarodowe / international holidays		✓			
kalendarz skrócony / shortened calendar 2023-2025		✓			
planer roczny / annual planner					
planer miesięczny / monthly planner					
kalendarz roczny / annual calendar 2024					
imieniny / name day		✓			
aforyzmy / aphorisms					
oświadczenie drogowe / accident statement					
notes / notebook		✓			
mapy / maps					

KALENDARZ / CALENDAR		505T	REGISTRY / INDEX		
format / format		297 × 105 mm biurkowy desk	drukowane printed	wycinane tabbed	perforacja narożników corner perforation
ilość stron / pages		128			
papier biały / white paper druk / print	szaro-bordowy grey-maroon				
	szaro-granatowy grey-dark blue				
	szaro-grafitowy grey-graphite	✓			
papier chamois/ ivory paper druk / print	szaro-bordowy grey-maroon				
	szaro-granatowy grey-dark blue				
	szaro-grafitowy grey-graphite	✓			
papier z recyklingu / recycled paper druk / print	szaro-grafitowy grey-graphite				
papier z trawy / grass paper druk / print	szaro-grafitowy grey-graphite				
papier z kamienia / stone paper druk / print	szaro-grafitowy grey-graphite				
język / language		PL GB DE IT UA			
dane personalne / personal data		✓			
licznik dni / day counter		✓			
numeracja tygodni / week numbering		✓			
karta planowania celów / goal planning sheet					
święta międzynarodowe / international holidays		✓			
kalendarz skrócony / shortened calendar 2023-2025		✓			
planer roczny / annual planner					
planer miesięczny / monthly planner					
kalendarz roczny / annual calendar 2024					
imieniny / name day		✓			
aforyzmy / aphorisms					
oświadczenie drogowe / accident statement					
notes / notebook		✓			
mapy / maps					

KALENDARZ / CALENDAR		509T	511T	512T	REGISTRY / INDEX		perforacja narożników corner perforation
format / format		149 × 203 mm ~A5	208 × 260 mm ~A4	167 × 240 mm ~B5	drukowane printed	wycinane tabbed	
ilość stron / pages		160	160	160			
papier biały / white paper druk / print	szaro-bordowy grey-maroon						
	szaro-granatowy grey-dark blue						
	szaro-grafitowy grey-graphite	✓	✓	✓			
papier chamois/ ivory paper druk / print	szaro-bordowy grey-maroon						
	szaro-granatowy grey-dark blue						
	szaro-grafitowy grey-graphite	✓		✓			
papier z recyklingu / recycled paper druk / print	szaro-grafitowy grey-graphite	✓		✓			
papier z trawy / grass paper druk / print	szaro-grafitowy grey-graphite	✓	✓	✓			
papier z kamienia / stone paper druk / print	szaro-grafitowy grey-graphite	✓	✓	✓			
język / language		PL GB DE IT UA					
dane personalne / personal data		✓	✓	✓			
licznik dni / day counter							
numeracja tygodni / week numbering		✓	✓	✓			
karta planowania celów / goal planning sheet		✓	✓	✓			
święta międzynarodowe / international holidays		✓	✓	✓			
kalendarz skrócony / shortened calendar 2023-2025		✓	✓	✓			
planer roczny / annual planner		✓	✓	✓			
planer miesięczny / monthly planner		✓	✓	✓			
kalendarz roczny / annual calendar 2024							
imieniny / name day		✓	✓	✓			
aforyzmy / aphorisms		✓	✓	✓			
oświadczenie drogowe / accident statement		✓	✓	✓			
notes / notebook		✓	✓	✓			
mapy / maps							

514T

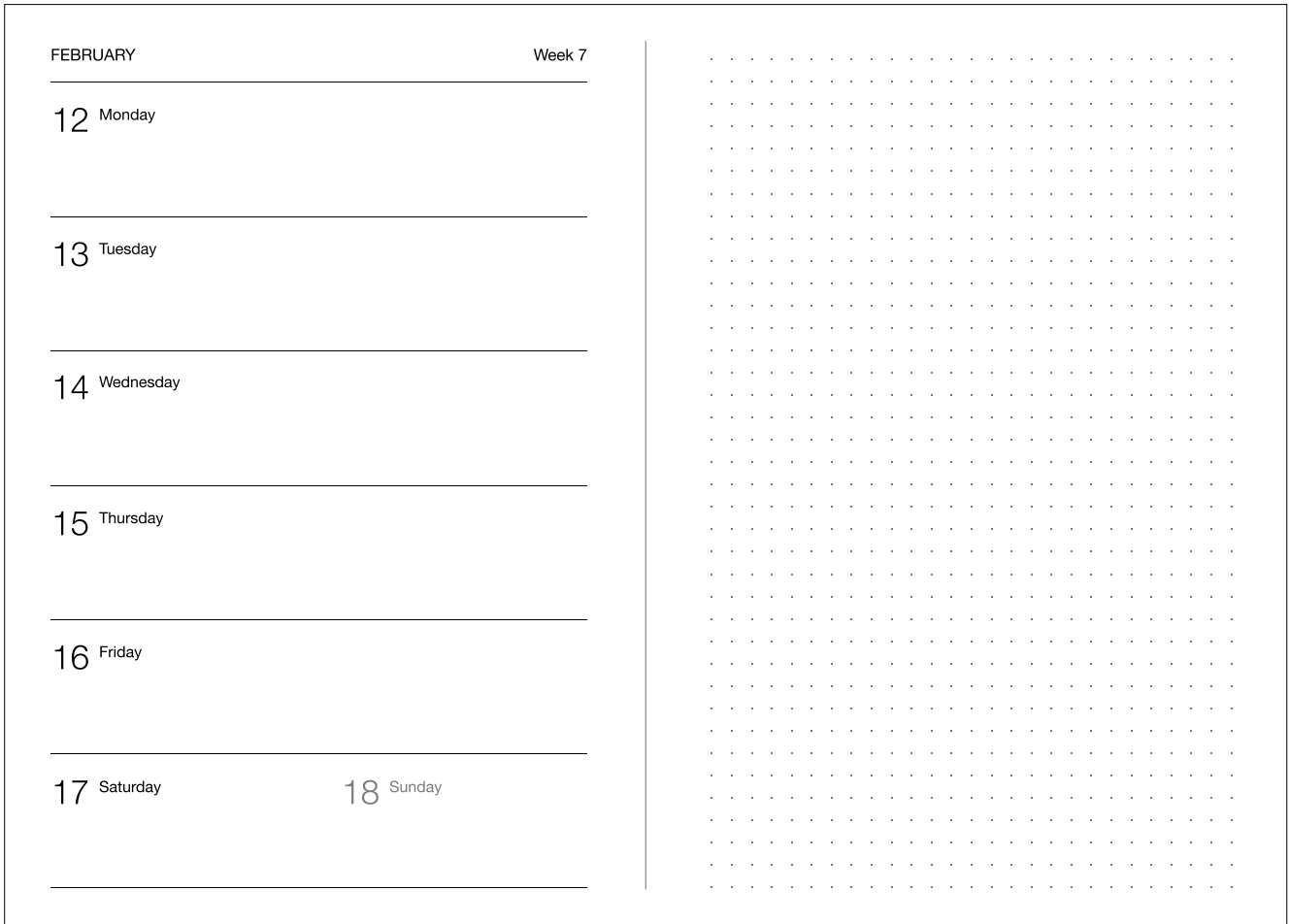

KALENDARZ / CALENDAR		514T	REGISTRY / INDEX		
format / format		167 × 240 mm ~B5	drukowane printed	wycinane tabbed	perforacja narożników corner perforation
ilość stron / pages		160			
papier biały / white paper druk / print	szaro-bordowy grey-maroon				
	szaro-granatowy grey-dark blue				
	szaro-grafitowy grey-graphite	✓			
papier chamois/ ivory paper druk / print	szaro-bordowy grey-maroon				
	szaro-granatowy grey-dark blue				
	szaro-grafitowy grey-graphite				
papier z recyklingu / recycled paper druk / print	szaro-grafitowy grey-graphite				
papier z trawy / grass paper druk / print	szaro-grafitowy grey-graphite				
papier z kamienia / stone paper druk / print	szaro-grafitowy grey-graphite				
język / language		GB			
dane personalne / personal data		✓			
licznik dni / day counter					
numeracja tygodni / week numbering		✓			
karta planowania celów / goal planning sheet		✓			
święta międzynarodowe / international holidays		✓			
kalendarz skrócony / shortened calendar 2023-2025		✓			
planer roczny / annual planner		✓			
planer miesięczny / monthly planner		✓			
kalendarz roczny / annual calendar 2024					
imieniny / name day					
aforyzmy / aphorisms					
oświadczenie drogowe / accident statement					
notes / notebook		✓			
mapy / maps					

BLOKI KALENDARZY TYGODNIOWYCH / WEEKLY CALENDARS LAYOUTS

516 167 × 240 mm



stonebook^o



KALENDARZ / CALENDAR		516	REGISTRY / INDEX		
format / format		167 × 240 mm ~B5	drukowane printed	wycinane tabbed	perforacja narożników corner perforation
ilość stron / pages		160			
papier biały / white paper druk / print	szaro-bordowy grey-maroon				
	szaro-granatowy grey-dark blue				
	szaro-grafitowy grey-graphite	✓			
papier chamois/ ivory paper druk / print	szaro-bordowy grey-maroon				
	szaro-granatowy grey-dark blue				
	szaro-grafitowy grey-graphite				
papier z recyklingu / recycled paper druk / print	szaro-grafitowy grey-graphite				
papier z trawy / grass paper druk / print	szaro-grafitowy grey-graphite				
papier z kamienia / stone paper druk / print	szaro-grafitowy grey-graphite	✓			
język / language		GB			
dane personalne / personal data		✓			
licznik dni / day counter					
numeracja tygodni / week numbering					
karta planowania celów / goal planning sheet					
święta międzynarodowe / international holidays					
kalendarz skrócony / shortened calendar 2023-2025					
planer roczny / annual planner		✓			
planer miesięczny / monthly planner					
kalendarz roczny / annual calendar 2024		✓			
imieniny / name day					
aforyzmy / aphorisms					
oświadczenie drogowe / accident statement					
notes / notebook		✓			
mapy / maps					

BLOKI NOTESOWE / NOTEBOOKS LAYOUTS

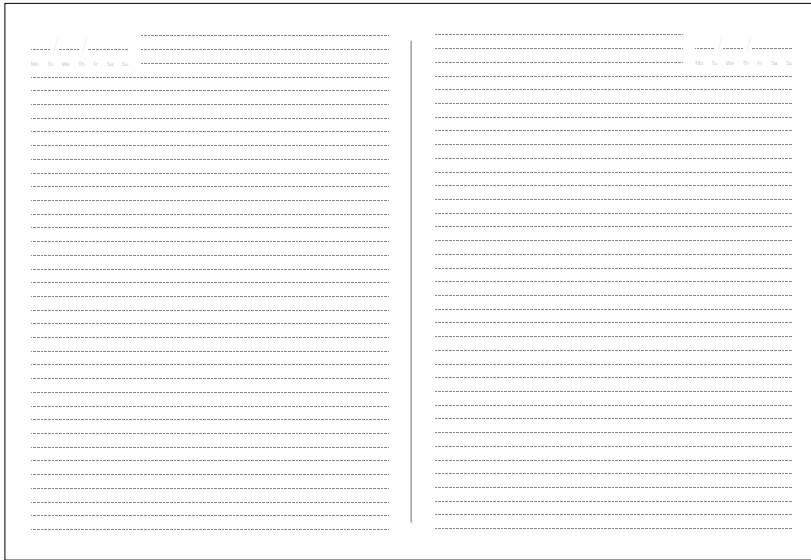

LINIA / LINE

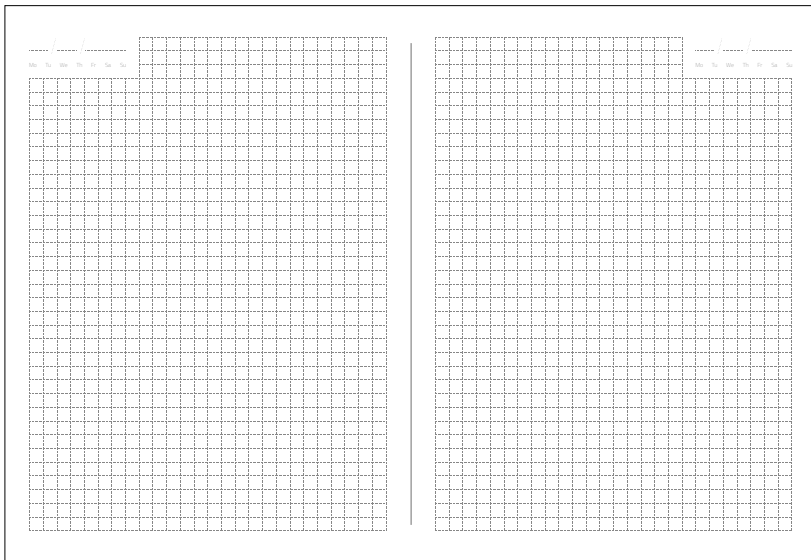

KRATKA / SQUARED

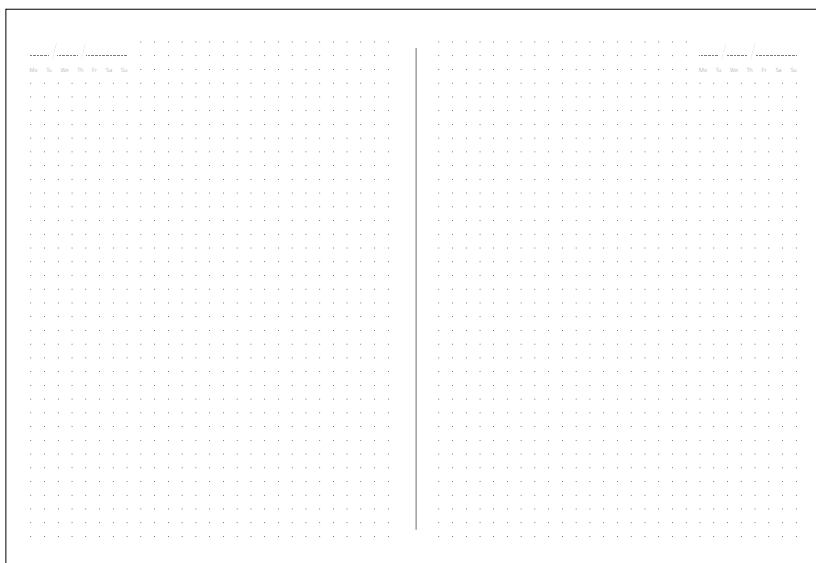

KROPKI / DOTS

NOTES / NOTEBOOK			~A6	~A5	~B5	~A4
format / format			105 × 140 mm	130 × 208 mm	167 × 240 mm	208 × 260 mm
ilość stron / pages			192	192	192	192
papier biały / white paper druk / print	grafitowy / graphite	linia / line	✓	✓	✓	
		kratka / squared	✓	✓	✓	✓
		kropki / dots		✓		
		gładki / plain	✓	✓		
papier chamois / ivory paper druk / print	grafitowy / graphite	linia / line		✓		
		kratka / squared		✓		
		kropki / dots				
		gładki / plain				
perforacja pionowa i pozioma na 16 ostatnich stronach / vertical and horizontal perforation of last 16 pages				✓	✓	✓

ilość stron / pages				192	192	
papier z recyklingu / recycled paper druk / print	grafitowy / graphite	linia / line				
		kratka / squared				
		kropki / dots		✓	✓	
		gładki / plain				
perforacja pionowa i pozioma na 16 ostatnich stronach / vertical and horizontal perforation of last 16 pages						

ilość stron / pages				144	144	
papier z trawy / grass paper druk / print	grafitowy / graphite	linia / line				
		kratka / squared		✓	✓	
		kropki / dots				
		gładki / plain				
perforacja pionowa i pozioma na 16 ostatnich stronach / vertical and horizontal perforation of last 16 pages						

ilość stron / pages				144	144	
papier z kamienia / stone paper druk / print	grafitowy / graphite	linia / line		✓	✓	
		kratka / squared		✓	✓	
		kropki / dots		✓		
		gładki / plain		✓		
perforacja pionowa i pozioma na 16 ostatnich stronach / vertical and horizontal perforation of last 16 pages						

język datownika / date stamp language	GB NIE DOTYCZY BLOKÓW NOTESOWYCH GŁADKICH / DOES NOT APPLY TO PLAIN NOTEBOOKS				
---------------------------------------	--	--	--	--	--



GADŻETY WYKONANE Z TROSKĄ O ŚRODOWISKO ZE SŁOMY PSZENICZNEJ W POŁĄCZENIU Z ABS. / GADGETS MADE WITH CARE FOR THE ENVIRONMENT MADE OF WHEAT STRAW TOGETHER WITH ABS.

**GADŻETY
STWORZONE
Z PSZENICY**

GADGETS
MADE OUT
OF WHEAT



PSZENICA · BETON I BAMBUS

WHEAT · CEMENT AND BAMBOO

SKOMPONUJ WŁASNY ECO SET / COMPOSE YOUR OWN ECO SET



GŁOŚNIK BLUETOOTH / BLUETOOTH SPEAKER

słoma pszenicy + ABS / wheat straw + ABS

G0009 numer katalogowy / catalogue number

- bluetooth / bluetooth: V 5.0
- głośnik / speaker: 3 W
- bateria / battery: 300 mAh
- mikrofon: prowadzenie rozmów w trybie zestawu głośnomówiącego / microphone: hands free calling
- wymiar / size: 87 × 72 × 40 mm
- metoda znakowania: druk UV / marking method: UV printing



POWERBANK / POWERBANK

słoma pszenicy + ABS / wheat straw + ABS

G0008 numer katalogowy / catalogue number

- bateria / battery: 5000 mAh
- kabel / cable: micro USB
- wejście / input: DC5V-2.0 A
- wyjście / output: DC5V-2.0 A
- wymiar / size: 94 × 63 × 14 mm
- metoda znakowania: druk UV / marking method: UV printing



ŁADOWARKA INDUKCYJNA / WIRELESS CHARGER

słoma pszenicy + ABS / wheat straw + ABS

G0012 numer katalogowy / catalogue number

- wejście / input: DC5V-2.0 A
- wyjście bezprzewodowe / wireless output: 5 W
- HUB 2 × USB
- wymiar / size: 90 × 90 × 9 mm
- metoda znakowania: druk UV / marking method: UV printing



ROZGAŁĘŹNIK USB DŁUGI /

LONG USB CHARGING CABLE **NEW**

słoma pszenicy + ABS / wheat straw + ABS

- złącza / connectors:
wejście / input **USB A/C**
wyjście / output **USB Micro/C, Lightning (iPhone)**
- wymiar / size: **1185 × 34 × 9 mm**
- metoda znakowania: **druk UV (dwustronnie)** / marking method: UV print (on both sides)
- opakowanie / packaging**

G0011 numer katalogowy / catalogue number

- wstawka / insert: **pszenica** / wheat



**PODŚWIETLANE
LOGO**

ILLUMINATED
LOGO

ROZGAŁĘŹNIK USB DŁUGI /

LONG USB CHARGING CABLE **NEW**

słoma pszenicy + ABS / wheat straw + ABS

- złącza / connectors:
wejście / input **USB A/C**
wyjście / output **USB Micro/C, Lightning (iPhone)**
- wymiar / size: **1185 × 34 × 9 mm**
- metoda znakowania: **grawer (jednostronnie)** / marking method: engraving (one side only)
- opakowanie / packaging**

G0029 numer katalogowy / catalogue number

- wstawka / insert: **biała** / white
- światło / light: **00** – białe / white



ROZGAŁĘŹNIK USB DŁUGI /

LONG USB CHARGING CABLE **NEW**

słoma pszenicy + ABS + bambus / wheat straw + ABS + bamboo

- złącza / connectors:
wejście / input **USB A/C**
wyjście / output **USB Micro/C, Lightning (iPhone)**
- wymiar / size: **1185 × 34 × 9 mm**
- metoda znakowania: **druk UV (jednostronnie)** / marking method: UV print (one side only)
- opakowanie / packaging**

G0030 numer katalogowy / catalogue number

- wstawka / insert: **bambus** / bamboo

*DOSTĘPNE OPAKOWANIA STR. 118-119. / AVAILABLE PACKAGING PP. 118-119.

**OPAKOWANIE STANDARD DO ROZGAŁĘŹNIKÓW ECO STR. 108. / STANDARD PACKAGING FOR THE ECO CHARGING CABLE PAGE 108.



**PODŚWIETLANE
LOGO**

ILLUMINATED
LOGO



**ROZGAŁĘZNIK USB DŁUGI /
LONG USB CHARGING CABLE ^{NEW}**
bambus + ABS / bamboo + ABS*

- złącza / connectors:
wejście / input USB A/C
wyjście / output USB C,
Lightning (iPhone)
- wymiar / size: 1220 × 35 × 10 mm
- metoda znakowania:
grawer (jednostronnie) /
marking method:
engraving (one side only)
- opakowanie / packaging**

G0031 numer katalogowy /
catalogue number

- wstawka / insert: czarna / black
- światło / light: 00 – białe / white



**PODŚWIETLANE
LOGO**

ILLUMINATED
LOGO

**ROZGAŁĘZNIK USB KRÓTKI /
SHORT USB CHARGING CABLE ^{NEW}**
bambus + ABS / bamboo + ABS*

- złącza / connectors:
wejście / input USB A/C
wyjście / output USB Micro/C,
Lightning (iPhone)
- wymiar / size: 162 × 37 × 10 mm
- metoda znakowania:
grawer (jednostronnie) /
marking method: engraving
(one side only)
- opakowanie / packaging**

G0032 numer katalogowy /
catalogue number

- wstawka / insert: czarna / black
- światło / light: 00 – białe / white

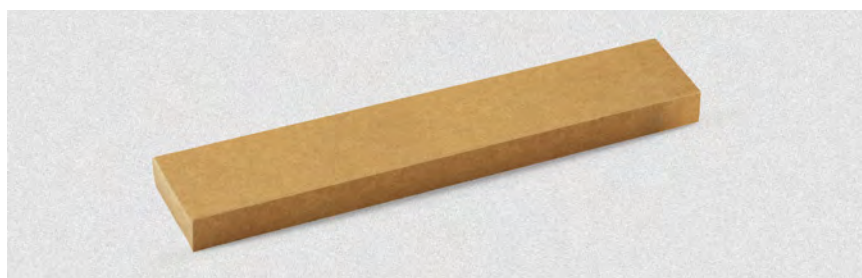

**OPAKOWANIE STANDARD /
STANDARD PACKAGING**

*DOSTĘPNE OPAKOWANIA STR. 118-119. / AVAILABLE PACKAGING PP. 118-119.

**OPAKOWANIE STANDARD DO ROZGAŁĘZNIKÓW ECO STR. 108. / STANDARD PACKAGING FOR THE ECO CHARGING CABLE PAGE 108.



ŁADOWARKA INDUKCYJNA STOJĄCA /
STAND WIRELESS CHARGER
cement + bambus / cement + bamboo

G0015 numer katalogowy / catalogue number

- wejście / input: DV5V-2 A
- wyjście bezprzewodowe / wireless output: 5 W
- wymiar / size: 124 × 98 × 98 mm
- metoda znakowania: druk UV / marking method: UV printing



ŁADOWARKA INDUKCYJNA / WIRELESS CHARGER **NEW**
bambus + rPET / bamboo + rPET

G0065 numer katalogowy / catalogue number

- wejście / input: DC 9V/2A, 12V/1.5A, 5V/2A,
- złącza /connectors: wejście / input USB A/C
- wyjście bezprzewodowe / wireless output: 15 W
- wymiar / size: 130 × 65 × 10 mm
- metoda znakowania: druk UV / marking method: UV printing



ŁADOWARKA INDUKCYJNA STOJĄCA / STAND WIRELESS CHARGER **NEW**
bambus + rPET / bamboo + rPET

G0066 numer katalogowy / catalogue number

- wejście / input: DC 9V/2A, 12V/1.5A, 5V/2A,
- złącza /connectors: wejście / input USB A/C
- wyjście bezprzewodowe / wireless output: 15 W
- wymiar / size: 155 × 100 × 10 mm
- metoda znakowania: druk UV / marking method: UV printing



ECO BOX 3

ŁADOWARKA INDUKCYJNA G0012 +
POWERBANK G0008 / WIRELESS CHARGER G0012
+ POWERBANK G0008



ECO BOX 4

POWERBANK G0008 + GŁOŚNIK BLUETOOTH
G0009 / POWERBANK G0008 + BLUETOOTH
SPEAKER G0009



ECO BOX 5

ŁADOWARKA INDUKCYJNA G0012 +
GŁOŚNIK BLUETOOTH G0009 /
WIRELESS CHARGER G0012 +
BLUETOOTH SPEAKER G0009



ECO BOX 7 NEW

POWERBANK G0008 + ROZGAŁĘŻNIK USB
DŁUGI G0029 / POWERBANK G0008 + LONG USB
CHARGING CABLE G0029



ECO BOX 8 NEW

POWERBANK G0008 + ROZGAŁĘŻNIK USB DŁUGI
G0011 / POWERBANK G0008 + LONG USB
CHARGING CABLE G0011



ECO BOX 9 NEW

GŁOŚNIK BLUETOOTH G0009 + ROZGAŁĘŻNIK
USB DŁUGI G0011 / BLUETOOTH SPEAKER G0009 +
LONG USB CHARGING CABLE G0011



POWER SET KRAFT 1 NEW

POWERBANK G0008 + ROZGAŁĘŻNIK
USB DŁUGI G0011 /
POWERBANK G0008 + LONG USB
CHARGING CABLE G0011



POWER SET KRAFT 2 NEW

POWERBANK G0008 + ROZGAŁĘŻNIK
USB DŁUGI G0029 /
POWERBANK G0008 + LONG USB
CHARGING CABLE G0029



POWER SET KRAFT 3 NEW

POWERBANK G0008 + ROZGAŁĘŻNIK
USB DŁUGI G0030 /
POWERBANK G0008 + LONG USB
CHARGING CABLE G0030



ECO SET 3

NOTES A5 + ŁADOWARKA INDUKCYJNA G0012 + POWERBANK G0008 /
A5 NOTEBOOK + WIRELESS CHARGER G0012 + POWERBANK G0008



ECO SET 4

NOTES A5 + POWERBANK G0008 + GŁOŚNIK BLUETOOTH G0009 /
A5 NOTEBOOK + POWERBANK G0008 + BLUETOOTH SPEAKER G0009



ECO SET 5

NOTES A5 + ŁADOWARKA INDUKCYJNA G0012 + GŁOŚNIK BLUETOOTH G0009 /
A5 NOTEBOOK + WIRELESS CHARGER G0012 + BLUETOOTH SPEAKER G0009

GADŻETY ECO / ECO GADGETS

ECO SET 7

NOTES A5 + ŁADOWARKA INDUKCYJNA
G0015 / A5 NOTEBOOK + WIRELESS
CHARGER G0015



ECO SET 8 **NEW**

NOTES A5 + ŁADOWARKA INDUKCYJNA
STOJĄCA G0066 / A5 NOTEBOOK +
STAND WIRELESS CHARGER G0066



ECO SET 9 NEW

NOTES A5 + ROZGAŁĘŻNIK USB DŁUGI G0031 +
DŁUGOPIS G0073 / A5 NOTEBOOK + LONG USB
CHARGING CABLE G0031 + PEN G0073



ROZGAŁĘŻNIKI USB / USB CHARGING CABLES



PODŚWIETLANE LOGO

ILLUMINATED
LOGO

ROZGAŁĘŻNIK USB KRÓTKI / SHORT USB CHARGING CABLE

- cztery porty zgodne z / four connectors compatible with: USB, Micro USB, USB C, Lightning (iPhone)
- wymiar / size: 160 × 35 × 10 mm
- metoda znakowania: grawer (dwustronnie) / marking method: engraving (on both sides)

G0026 numer katalogowy / catalogue number

- kolor / colour: granatowy / navy blue
- światło / light: **00** – białe / white

G0027 numer katalogowy / catalogue number

- kolor / colour: czerwony / red
- światło / light: **00** – białe / white



PODŚWIETLANE LOGO

ILLUMINATED
LOGO



PODŚWIETLANE LOGO

ILLUMINATED
LOGO

ROZGAŁĘŻNIK USB KRÓTKI / SHORT USB CHARGING CABLE

- złącza / connectors: wejście / input USB A/C, wyjście / output USB Micro/C, Lightning (iPhone)
- wymiar / size: 153 × 35 × 10 mm
- metoda znakowania / marking method:
grawer (dwustronnie) / engraving (on both sides) – **G0067, G0068**
druk UV (dwustronnie) / UV print (on both sides) – **G0067**

G0067 numer katalogowy / catalogue number

- kolor / colour: biały / white
- światło / light: **00** – białe / white, **02** – czerwone / red, **03** – pomarańczowe / orange

G0068 numer katalogowy / catalogue number

- kolor / colour: czarny / black
- światło / light: **00** – białe / white, **02** – czerwone / red, **07** – niebieskie / blue

**DRUK UV
Z PODŚWIETLANYMI
ELEMENTAMI**

UV PRINT
WITH ILLUMINATED
ELEMENTS



**PODŚWIETLANE
LOGO**

ILLUMINATED
LOGO



**PODŚWIETLANE
LOGO**

ILLUMINATED
LOGO



ROZGAŁĘZNIK USB DŁUGI / LONG USB CHARGING CABLE

- złącza / connectors: wejście / input USB A/C, wyjście / output USB Micro/C, Lightning (iPhone)
- wymiar / size: 1205 × 34 × 9 mm
- metoda znakowania / marking method:
 - grawer (jednostronnie) / engraving (one side only) – **G0069, G0070**
 - druk UV (jednostronnie) / UV print (one side only) – **G0069**

G0069 numer katalogowy / catalogue number

- kolor / colour: biały / white
- światło / light: **00** – białe / white

G0070 numer katalogowy / catalogue number

- kolor / colour: czarny / black
- światło / light: **00** – białe / white

ROZGAŁĘŻNIKI USB / USB CHARGING CABLES

OPAKOWANIE NA ROZGAŁĘŻNIKI / PACKAGING FOR USB CHARGING CABLES

FOLIA Z DRUKOWANYM DWUSTRONNIE KARTONIKIEM WG AUTORSKIEGO PROJEKTU
FOIL WITH PRINTED CARDBOARD ON BOTH SIDES ACCORDING TO CUSTOMISED DESIGN

- wymiar (rozgałęźnik krótki) / size (short charging cable): 198 × 70 mm
- wymiar (rozgałęźnik długi) / size (long charging cable): 230 × 70 mm



PAPIER BARWIONY W MASIE / MASS DYED PAPER

- wymiar (rozgałęźnik krótki) / size (short charging cable): 180 × 53 × 16 mm
- wymiar (rozgałęźnik długi) / size (long charging cable): 210 × 60 × 25 mm

OPAKOWANIE NA ROZGAŁĘŻNIK DŁUGI PACKAGING FOR LONG CHARGING CABLE



OPAKOWANIE NA ROZGAŁĘŻNIK KRÓTKI PACKAGING FOR SHORT CHARGING CABLE

OPAKOWANIE NA ROZGAŁĘŻNIK DŁUGI Z NADRUKIEM
PACKAGING FOR LONG CHARGING CABLE WITH PRINT



OPAKOWANIE NA ROZGAŁĘŻNIK KRÓTKI Z NADRUKIEM
PACKAGING FOR SHORT CHARGING CABLE WITH PRINT

PAPIER BARWIONY W MASIE LUB KRAFTOWY Z NADRUKIEM CZARNYM /
MASS DYED PAPER OR KRAFT WITH BLACK PRINT **NEW**

- wymiar (rozgałęźnik krótki) / size (short charging cable): 180 × 60 × 20 mm
- wymiar (rozgałęźnik długi) / size (long charging cable): 215 × 70 × 20 mm

OPAKOWANIE NA ROZGAŁĘŻNIK DŁUGI Z NADRUKIEM CZARNYM
PACKAGING FOR LONG CHARGING CABLE WITH BLACK PRINT



OPAKOWANIE NA ROZGAŁĘŻNIK KRÓTKI Z NADRUKIEM CZARNYM
PACKAGING FOR SHORT CHARGING CABLE WITH BLACK PRINT

POWERBANKI / POWERBANKS



POWERBANK / POWERBANK

G0003 numer katalogowy / catalogue number

- kolor / colour: **01** – czarny / black, **02** – czerwony / red, **08** – granatowy / navy blue
- pojemność baterii / battery capacity: **4000 mAh**
- czterostopniowy poziom naładowania / four stage charging level
- żywotność: ok. **500 ładowań** / number of charging cycles: approx 500
- wejście / input: **Micro USB**
- wyjścia / output: **USB × 2**
- wymiar / size: **138 × 66 × 9 mm**
- metoda znakowania: **grawer (jednostronnie)** / marking method: engraving (one side only)

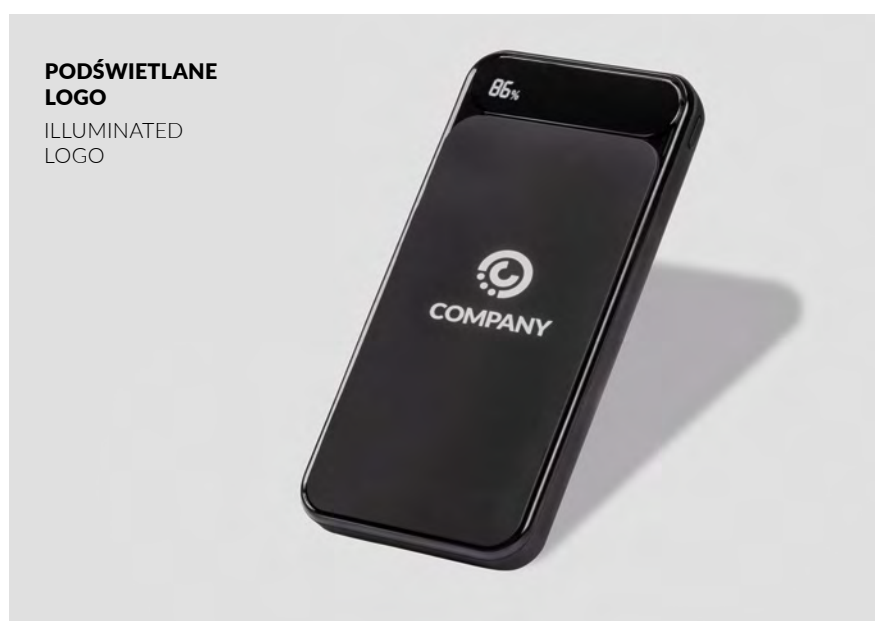

POWERBANK / POWERBANK **NEW**

G0074 numer katalogowy /
catalogue number

- kolor / colour: **01** – czarny / black
- pojemność baterii / battery capacity: **10 000 mAh**
- wyświetlacz cyfrowy: procent naładowania / digital display: charge percentage
- żywotność: ok. **500 ładowań** / number of charging cycles: approx 500
- wejście / input: **Micro USB, USB C - DC5V/2A**
- wyjścia / output: **USB x2 - DC5V/2A (maks. 2,1A)**
- wymiar / size: **132,1 × 67 × 20,6 mm**
- metoda znakowania: **grawer (jednostronnie)** / marking method: engraving (one side only)

ENERGY SET



ENERGY SET





KALENDARZ/NOTES + POWERBANK + ROZGAŁĘŻNIK USB KRÓTKI /
CALENDAR/NOTEBOOK + POWERBANK + SHORT USB CHARGING CABLE

kolor zestawu / set colour

czarny / black
granatowy / navy blue
czerwony / red

kalendarz lub notes / calendar or notebook

503D, 509T, 510D – kalendarz / calendar
lub / or
A5 – notes / notebook

opakowanie / packaging

czarny papier barwiony w masie / black mass dyed paper

znakowanie opakowania / marking method of the packaging

sitodruk / silk-screen

POWER SET

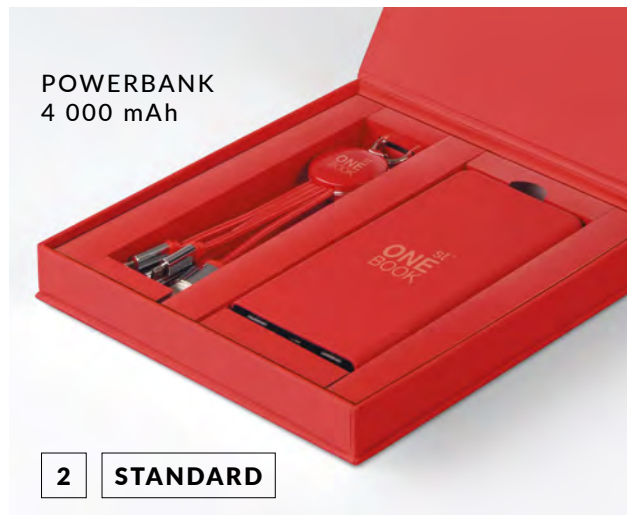
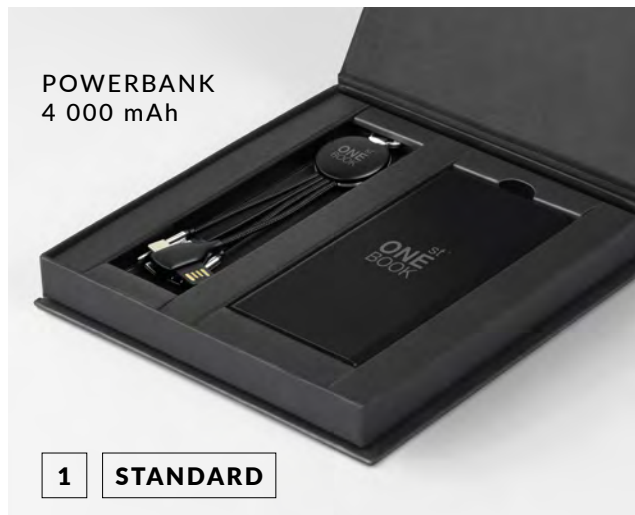

POWERBANK + ROZGAŁĘŹNIK USB KRÓTKI / POWERBANK + SHORT USB CHARGING CABLE

kolor zestawu / set colour

opakowanie / packaging

znakowanie opakowania / marking method of the packaging

czarny / black
czerwony / red
granatowy / navy blue
czarny / black **NEW**

w kolorze zestawu / in the set colour

sitodruk / silk-screen



POWERBANK
4 000 mAh

5 LONG

NEW

POWERBANK
10 000 mAh

6 LONG PLUS

POWERBANK + ROZGAŁĘŻNIK USB DŁUGI / POWERBANK + LONG USB CHARGING CABLE

kolor zestawu / set colour

czarny / black

opakowanie / packaging

w kolorze zestawu / in the set colour

znakowanie opakowania / marking method of the packaging

sitodruk / silk-screen

WHITE BOX & BLACK BOX





NOTES + ROZGAŁĘŻNIK USB STANDARD + OZDOBNE PUDEŁKO WIECZKOWE /
NOTEBOOK + USB CHARGING CABLE + DECORATIVE LID BOX

kolor zestawu / set colour

czarny / black

biały / white

kalendarz lub notes / calendar or notebook

pod każdy format z wykluczeniem kalendarza 501D, 505T /
for any format except 501D, 505T calendar

kolor rozgałęźnika / charger colour

biały / white

czarny / black

opakowanie / packaging

papier barwiony w masie czarny / black mass dyed paper

karton biały / white cardboard

ZESTAWIENIE BLOKÓW / LIST OF BLOCKS

KALENDARZ DZIENNY / DAILY CALENDAR

BLOK BLOCK	ILOŚĆ STRON NUMBER OF PAGES	FORMAT BLOKU BLOCK FORMAT	PAPIER / PAPER				PLANER MIESIĘCZNY MONTHLY PLANNER	PERFORACJA NAROŻNA CORNER PERFORATION	AFORYZMY APHORISMS	REGISTRY / INDEX	
			BIAŁY WHITE	CHAMOIS IVORY	Z RECYKLINGU RECYCLED	DRUK PRINT*				WYCINANE TABBED	DRUKOWANE PRINTED
501D	368	200 × 280 mm	✓	✓		●●●	✓	✓	✓	✓	✓
503D	368	143 × 203 mm	✓	✓		●●●	✓	✓	✓	✓	✓
503D	368	143 × 203 mm			✓	●●	✓		✓		✓
506D	368	110 × 160 mm	✓			●●	✓		✓		✓
508D	368	162 × 240 mm	✓	✓		●●●	✓	✓	✓	✓	✓
510D	368	143 × 203 mm	✓			●●	✓				✓

* ●● / ●●● / ●●● kolor druku / print colour

KALENDARZ TYGODNIOWY / WEEKLY CALENDAR

BLOK BLOCK	ILOŚĆ STRON NUMBER OF PAGES	FORMAT BLOKU BLOCK FORMAT	PAPIER / PAPER					DRUK PRINT*	PLANER MIESIĘCZNY MONTHLY PLANNER	PERFORACJA NAROŻNA CORNER PERFORATION	AFORYZMY APHORISMS	REGISTRY / INDEX	
			BIAŁY WHITE	CHAMOIS IVORY	Z RECYKLINGU RECYCLED	Z TRAWY GRASS	Z KAMIENIA STONE					WYCINANE TABBED	DRUKOWANE PRINTED
502T	160	208 × 260 mm	✓	✓				●●●	✓	✓	✓	✓	✓
504T	128	84 × 151 mm	✓	✓				●●					✓
505T	128	297 × 105 mm	✓	✓				●●					
507T	160	167 × 240 mm	✓	✓				●●●	✓	✓	✓	✓	✓
					✓			●●		✓		✓	✓
509T	160	149 × 203 mm	✓	✓	✓	✓	✓	●●		✓	✓		
511T	160	208 × 260 mm	✓			✓	✓	●●		✓	✓		
512T	160	167 × 240 mm	✓		✓	✓	✓	●●		✓	✓		
514T	160	167 × 240 mm	✓					●●		✓			

* ●● / ●●● / ●●● kolor druku / print colour

KALENDARZ ROCZNY Z NOTESEM / ANNUAL CALENDAR WITH NOTEBOOK

BLOK BLOCK	ILOŚĆ STRON NUMBER OF PAGES	FORMAT BLOKU BLOCK FORMAT	PAPIER / PAPER		
			BIAŁY WHITE	Z KAMIENIA STONE	DRUK PRINT*
516	160	167 × 240 mm	✓	✓	●●

* ●● kolor druku / print colour

NOTES / NOTEBOOK

BLOK BLOCK	ILOŚĆ STRON NUMBER OF PAGES	FORMAT BLOKU BLOCK FORMAT	PAPIER / PAPER					GŁADKI PLAIN	LINIA LINE	KRATKA SQUARED	KROPKI DOTS	PERFORACJA PERFORATION**
			BIAŁY WHITE	CHAMOIS IVORY	Z RECYKLINGU RECYCLED	Z TRAWY GRASS	Z KAMIENIA STONE					
A6	192	105 × 140 mm	✓					●	✓	✓	✓	
A5	192	130 × 208 mm	✓					●	✓	✓	✓	✓
	192	130 × 208 mm		✓				●		✓	✓	✓
	192	130 × 208 mm			✓			●			✓	
	144	130 × 208 mm				✓		●		✓		
	144	130 × 208 mm					✓	●	✓	✓	✓	
B5	192	167 × 240 mm	✓					●	✓	✓		✓
	192	167 × 240 mm			✓			●			✓	
	144	167 × 240 mm				✓		●		✓		
	144	167 × 240 mm					✓	●	✓	✓		
A4	192	208 × 260 mm	✓					●		✓		✓

* ●● kolor druku / print colour

**PERFORACJA PIONOWA I POZIOMA NA 16 OSTATNICH STRONACH / VERTICAL AND HORIZONTAL PERFORATION OF LAST 16 PAGES

Ze względu na ograniczenia wynikające z techniki druku, rzeczywiste kolory poszczególnych towarów mogą nieznacznie różnić się od kolorów prezentowanych na zdjęciach. Podane wymiary są wymiarami orientacyjnymi i nie mogą stanowić podstawy reklamacji. Producent zastrzega sobie prawo do technicznych zmian poszczególnych produktów, a także nie ponosi odpowiedzialności za ewentualne błędy w druku. Wszystkie znaki firmowe zamieszczone w katalogu są własnością ich autorów i zaprezentowane są jedynie w celach poglądowych. Katalog nie stanowi oferty w myśl przepisów kodeksu cywilnego. Produkcja w Polsce. / Due to restrictions of printing techniques, actual colours may slightly vary from the ones presented in the catalogue. The sizes and formats provided are for reference only and cannot be the subject of complaint. The manufacturer reserves the right to technical modifications, as well as is not responsible for any possible printing errors. All the trademarks that appear in the catalogue are the property of their authors and are presented for reference only. The catalogue does not constitute an offer within the meaning of the Civil Code. Made in Poland.